



ACRYLIC DISPLAY

PERIMETER HARDWARE

GRIDWALL

RACK SIGNAGE

DISPLAY MERCHANDISING

MANNING

SECURITY SUPPLIES

RETAIL'S SYSTEM

DISPLAY SYSTEM

SHOWCASE



A&A DISPLAYS INC

2044 GLADWICK ST.
RANCHO DOMINGUEZ, CA 90220
TEL. 310-537-7705
FAX. 310-537-5456
www.aadisplayus.com

2018 - 2019 PRODUCT LINE OVERVIEW



Displays Solution Leader
Store Fixtures System and
Custom Fabrication



A&A DISPLAYS INC

2044 GLADWICK ST. RANCHO DOMINGUEZ, CA 90220
TEL. 310-537-7705 FAX. 310-537-5456
www.aadisplayus.com

NEW ARRIVALS

NEW ARRIVALS 3 - 10

MANNEQUINS

NEW MANNEQUINS 11 - 14
 FEMALE MANNEQUINS 15 - 24
 MALE MANNEQUINS 25 - 28
 GHOST & ROBOT MANNEQUINS 29 - 30
 BRAZILIAN & AFRICAN MANNEQUINS 31 - 32
 CHILDREN MANNEQUINS 33 - 34
 BODY FORMS & BASES 35 - 39
 MANNEQUIN PARTS & PLASTIC FORMS 40 - 42

RETAIL SYSTEMS

KUPO DISPLAY (KLAMP POLE) 43 - 52
 *NEW * ELDURA SYSTEM 53 - 54
 PIPE RACK (PL) 55 - 60
 SLOTTED SYSTEM (AK) 61 - 62
 LADDER SYSTEM (HL) 63 - 64

SHOWCASES & COUNTERS

LIGHTED TOWER, FRAMELESS GLASS 65 - 67
 EXTRAVISION, FULL VISION, HALF VISION 68 - 69
 COUNTERS, WALL DISPLAYS, REGISTER & COUNTERTOP 70 - 72

SLATWALL MERCHANDISERS & ACCESSORIES

SLATWALL MERCHANDISERS 75 - 76
 HOOKS, BRACKETS, FACEOUTS, WATERFALLS & HANGRAILS 77 - 79
 DISPLAYERS: BINS, SHOE SHELVES, SIGN HOLDERS & WIRE BASKETS 80 - 83

COUNTERTOP DISPLAYS

METAL: JEWELRY, HANDBAG & MULTI-PURPOSE 85 - 89
 ACRYLIC: JEWELRY, EYEWEAR, ACCESSORY BINS 90 - 92
 ACRYLIC: E-CIG/VAPOR, HEADPHONE, CELL PHONE 93 - 94
 ACRYLIC: CUBES, RISERS, EASELS & SIGN HOLDERS 95 - 97
 SHOWCASES, MERCHANDISERS & WIRE DISPLAYS 98 - 100

RACKS & ACCESSORIES

RACKS: GARMENT, "H", ROUND, ROLLING & ACCESSORIES 101 - 104
 RACKS: SPECIALTY, SHOE RACKS & ACCESSORIES 105 - 108

DISPLAY TABLES, DUMP TABLES, WIRE DISPLAYS & RISERS & CUBES

C-STORE, IMPULSE, WICKER BASKET DISPLAYS 109 - 112
 DUMP TABLES & BINS 113 - 114
 CAP, GREETING CARD & ACRYLIC BOWL DISPLAYS 114 - 116
 WOOD TIER TABLES & SUNGLASS DISPLAYS 117 - 118
 DISPLAY TABLES, RISERS & CUBES 119 - 122

SHELVING

WOOD BASE CONNECTORS & SHELVING 123 - 124

GRID PANELS & ACCESSORIES

GRID PANELS & BASES 125
 HOOKS, BRACKETS, FACEOUTS, WATERFALLS & HANGRAILS 126 - 127
 DISPLAYERS: BINS, SHOE SHELVES, SIGN HOLDERS & WIRE BASKETS 127 - 128

STANDARD HARDWARE

MEDIUM SLOTTED DUTY & ACCESSORIES 129 - 130
 HEAVY SLOTTED DUTY & ACCESSORIES 131
 TUBING & ACCESSORIES 132 - 133

SIGNAGE

BULLETIN, POP CLIP-ON, STEM MOUNT 134 - 136

SUPPLY DEPARTMENT

STANCHIONS, TURN TABLES & SECURITY MIRRORS 137 - 138
 FULL LENGTH MIRRORS, HANGERS & POLY DISPENSING RACK 139 - 140
 TAGGING GUNS, MESSAGE, PRICE CARDS, ZIP & OPP BAGS 141 - 142

SALES POLICY

Amko Displays is a supplier to distributors and wholesalers of retail fixtures, displays, mannequins, and store supplies.
 We have also step forward into manufacturing custom retail fixtures & displays for national chain accounts. Unfortunately, we don't supply to independent retailers.
 All accounts are required to fill out a "New Customer Application".

SHIPPING POLICY

Unless otherwise specified, all LTL (truck) shipments will be arranged through our freight agents. Freight will be prepaid and added to the merchandise invoice.
 Small package orders will ship via UPS. We can ship FEDEX Ground as long as the customer provides us with the labels.

RETURN POLICY

Returnable Items:
 All returns are required to have written approval from Amko Displays, prior to return.
 All returns must be in the original packaging and be made within 30 days of receipt.
 Returns must be shipped back at customer's expense and are subject to a 25% restocking fee.
 Upon inspection, all returns will be in the form of credit towards customer's account.

Non returnable items:

Due to the fragility of mannequins, body forms, showcases and glass items will not be returnable.

CLAIMS POLICY

Claims for damaged goods or shortages must be noted on receipt at the time of delivery. For LTL freight shipments, damages or shortages must be noted on the BOL.
 Claims for damages & shortages must be reported to Amko within five (5) days of receipt of goods, otherwise, Amko will not be responsible for any freight charges for replacements.

Note for showcases, any glass shipments- these items are inspected and packed properly by warehouse prior to shipping. Once you receive this shipment- it must be thoroughly inspected that nothing is broken prior to receiving as we will not be responsible once the trucking leaves your shipment with you.

Filing damage claims with UPS & LTL are the customer's responsibility, if the billing account is the customer's.

PRICING & PAYMENT POLICY

Prices are subject to change without notice.
 All major credit cards are only accepted for prepayment of orders. **There will be a 2% credit card fee.**
 To apply for credit, please fill out and provide references as requested in the "New Customer Application".

REPACKING POLICY

There will be a broken box fee of \$3.00 for any items not purchased in standard packing quality.

SMALL ORDER/DROP SHIP POLICY

The minimum order amount will be \$50.00. Anything under that will incur a \$5.00 surcharge fee.

2018



Page 12



Page 12



Page 12



Page 14



Page 14



Page 30



Page 30



Page 13



Page 16



Page 33



Page 29



Page 35

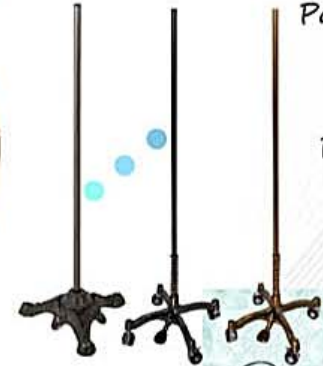

Page 38

NEW ARRIVALS!

NEW ARRIVALS

NEW ARRIVALS

The
MANNEQUINS
PROJECT

2018

NEW ARRIVALS!



Page 60



Page 56



Page 58



Page 56



Page 59



Page 53



Page 60



Page 59



Page 105



Page 103



Page 59



Page 60



Page 54

The
FIXTURES
PROJECT

NEW ARRIVALS

NEW ARRIVALS

2018

NEW ARRIVALS!

Page 82



Page 116



Page 80



Page 121



Page 119



Page 87



Page 87



Page 82



Page 99



Page 53



Page 67



Page 70



Page 68



Page 119

The
DISPLAYS
PROJECT

NEW ARRIVALS

NEW ARRIVALS

2018

Page 137



Page 137



Page 87

NEW ARRIVALS!



Page 110



Page 110



Page 140



Page 113



Page 77

Page 113



Page 134



Page 77



Page 72

Page 114



Page 81



Page 72

Page 135



Page 110

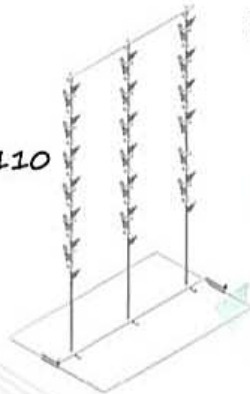

Page 110



The
DISPLAYS
PROJECT

NEW ARRIVALS

NEW ARRIVALS

**METALLIC GREY
SPORTS**

ATHELEISURE MANNEQUINS



ATHELEISURE MANNEQUINS



**METALLIC GREY
SPORTS**



BEN/1



BEN/2



JACKIE/1



JACKIE/2



JACKIE/3

BEN / JACKIE SERIES

PRODUCT DESCRIPTION

ITEM	HEIGHT	CHEST	WAIST	HIP	BASE	PACK	WEIGHT
BEN/1	5'10"	44"	35"	42"	CHROME- RECTANGULAR	1	54
BEN/2	5'6"	36"	28"	36"	CHROME- RECTANGULAR	1	51
JACKIE/1	5'3"	35"	27"	36"	CHROME- RECTANGULAR	1	38
JACKIE/2	5'4"	34"	27"	36"	CHROME- RECTANGULAR	1	34
JACKIE/3	5'3"	36"	27"	34"	CHROME- RECTANGULAR	1	38

**MATTE WHITE
ABSTRACT**

FEMALE MANNEQUINS

FEMALE MANNEQUINS

**MATTE/GLOSSY WHITE
PLUS SIZE**



JESSICA/1



JANET/1
MATTE GLOSSY



JANET/2
MATTE GLOSSY



JESSICA/2



JESSICA/3



JESSICA/4

JESSICA SERIES

PRODUCT DESCRIPTION

ITEM	HEIGHT	CHEST	WAIST	HIP	BASE	PACK	WEIGHT
JESSICA/1	5'8"	34"	26"	36 1/2"	CHROME- ROUND	1	33
JESSICA/2	5'8"	34"	26"	36 1/2"	CHROME- ROUND	1	33
JESSICA/3	5'8"	34"	26"	37"	CHROME- ROUND	1	34
JESSICA/4	5'8"	34"	26"	37"	CHROME- ROUND	1	34



JANET/3
GLOSSY



JANET/4
GLOSSY



JANET/5
GLOSSY

JANET SERIES

PRODUCT DESCRIPTION

ITEM	HEIGHT	CHEST	WAIST	HIP	BASE	PACK	WEIGHT
JANET/1	5'	43"	34"	44"	CHROME- ROUND	1	34
JANET/2	6'	43"	34"	44"	CHROME- ROUND	1	34
JANET/3	6'	41"	34"	44"	CHROME- ROUND	1	39
JANET/4	6'	41"	33"	43"	CHROME- ROUND	1	39
JANET/5	4'8"	41"	33"	43"	SITTING STOOL	1	39

**MATTE WHITE
ABSTRACT**

FEMALE MANNEQUINS



FEMALE MANNEQUINS

**MATTE WHITE
ABSTRACT**

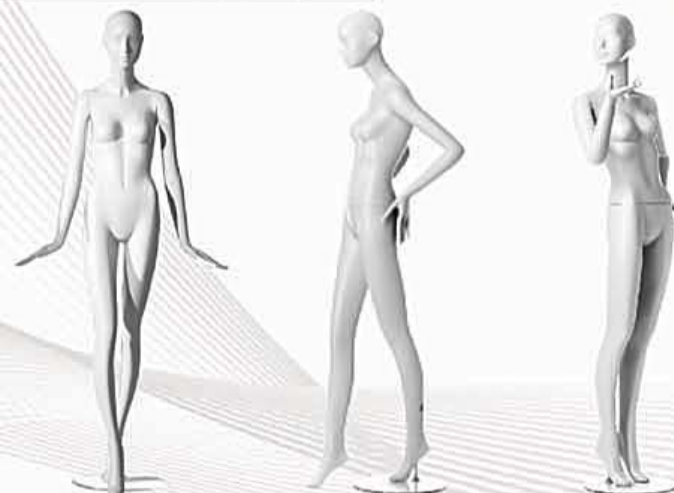

KATE/1

KATE/2

KATE/3



KATE/6



KATE/5



KATE/4

KATE SERIES

PRODUCT DESCRIPTION

ITEM	HEIGHT	CHEST	WAIST	HIP	BASE	PACK	WEIGHT
KATE/1	6'	33"	24"	35"	CHROME- ROUND	1	28
KATE/2	6'	33"	24"	35"	CHROME- ROUND	1	28
KATE/3	6'	33"	24"	35"	CHROME- ROUND	1	28
KATE/4	5'8"	33"	24"	35"	SITTING STOOL	1	33
KATE/5	6'	33"	24"	35"	CHROME- ROUND	1	28
KATE/6	6'	33"	24"	35"	CHROME- ROUND	1	28

**GLOSSY WHITE
REALISTIC**

FEMALE MANNEQUINS

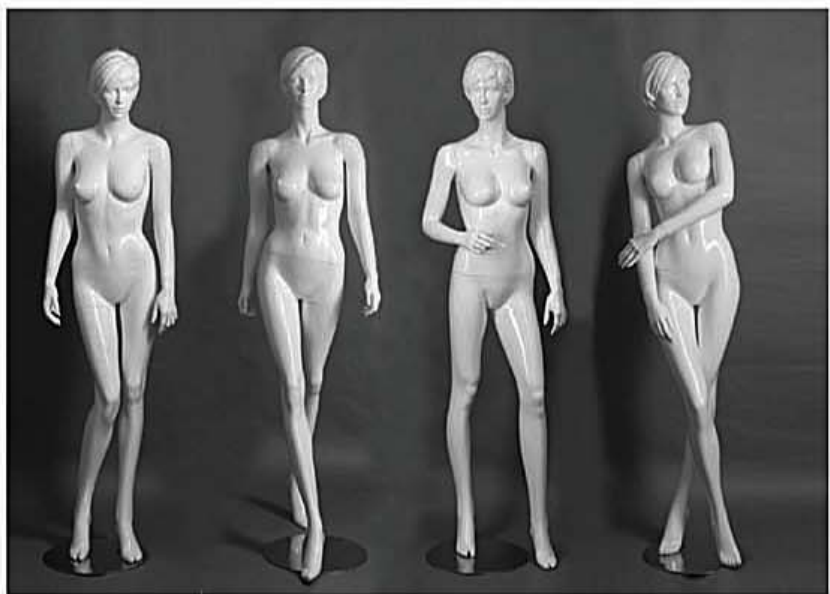

FEMALE MANNEQUINS

**GLOSSY WHITE
REALISTIC**

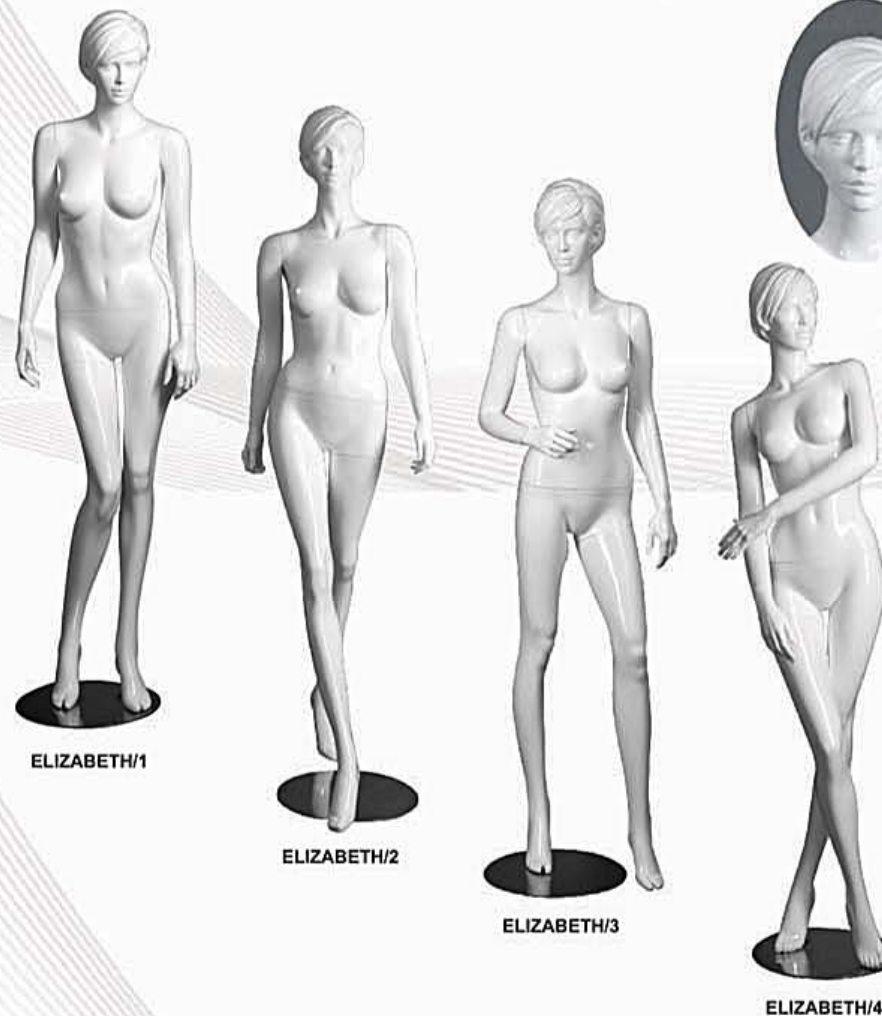

ELIZABETH SERIES

PRODUCT DESCRIPTION

ITEM	HEIGHT	CHEST	WAIST	HIP	BASE	PACK	WEIGHT
ELIZABETH/1	5'9"	34"	25"	35"	CHROME- ROUND	1	28
ELIZABETH/2	5'9"	34"	25"	35"	CHROME- ROUND	1	28
ELIZABETH/3	5'9"	34"	25"	35"	CHROME- ROUND	1	28
ELIZABETH/4	5'9"	34"	25"	35"	CHROME- ROUND	1	28

**GLOSSY WHITE
ABSTRACT**

FEMALE MANNEQUINS



BELLA/1

BELLA/2



BELLA/5



BELLA/3



BELLA/4

BELLA SERIES

PRODUCT DESCRIPTION

ITEM	HEIGHT	CHEST	WAIST	HIP	BASE	PACK	WEIGHT
BELLA/1	5'9"	33"	24"	34"	CHROME-ROUND	1	28
BELLA/2	5'9"	33"	24"	34"	CHROME-ROUND	1	28
BELLA/3	5'9"	33"	24"	34"	CHROME-ROUND	1	28
BELLA/4	5'9"	33"	24"	34"	CHROME-ROUND	1	28
BELLA/5	4'4"	33"	24"	34"	SITTING STOOL	1	33

FEMALE MANNEQUINS

**GLOSSY WHITE
ABSTRACT**

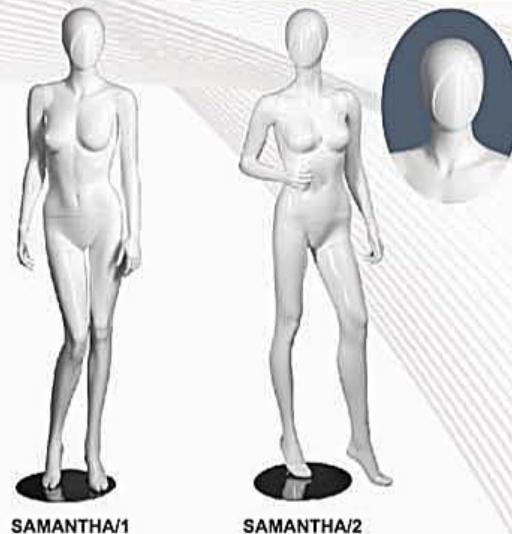

SAMANTHA/1

SAMANTHA/2



SAMANTHA/3



SAMANTHA/4



SAMANTHA/5

SAMANTHA SERIES

PRODUCT DESCRIPTION

ITEM	HEIGHT	SHOULDER	CHEST	WAIST	HIP	BASE	PACK	WEIGHT
SAMANTHA/1	5'8"	16"	33"	24 1/2"	34"	CHROME-ROUND	1	28
SAMANTHA/2	5'8"	16"	33"	24 1/2"	34"	CHROME-ROUND	1	28
SAMANTHA/3	5'8"	16"	33"	24 1/2"	34"	CHROME-ROUND	1	28
SAMANTHA/4	5'8"	16"	33"	24 1/2"	34"	CHROME-ROUND	1	28
SAMANTHA/5	5'8"	16"	33"	24 1/2"	34"	SITTING STOOL	1	33

**MATTE WHITE
HEADLESS**

FEMALE MANNEQUINS

FEMALE MANNEQUINS

**GLOSSY WHITE/GLOSSY BLACK
ABSTRACT**



ERICA/1



ERICA/2



MICHELLE/1



MICHELLE/2



ERICA/5



ERICA/3



ERICA/4



MICHELLE/3



MICHELLE/4



MICHELLE/5

ERICA SERIES

MICHELLE SERIES

PRODUCT DESCRIPTION

ITEM	HEIGHT	SHOULDER	CHEST	WAIST	HIP	BASE	PACK	WEIGHT
ERICA/1	5'2"	15 3/4"	32 1/2"	23 1/2"	34 1/4"	CHROME- ROUND	1	28
ERICA/2	5'2"	15 3/4"	32 1/2"	23 1/2"	34 1/4"	CHROME- ROUND	1	28
ERICA/3	5'2"	17 3/4"	32 1/2"	24"	34"	CHROME- ROUND	1	28
ERICA/4	5'2"	16"	33"	25 1/4"	36 1/4"	CHROME- ROUND	1	28
ERICA/5	3'2"	15 3/4"	32 1/2"	23 1/2"	34 1/4"	SITTING STOOL	1	33

PRODUCT DESCRIPTION

ITEM	HEIGHT	SHOULDER	CHEST	WAIST	HIP	BASE	PACK	WEIGHT
MICHELLE/1	5'9"	15 3/4"	32 1/2"	23 1/2"	34 1/4"	CHROME- ROUND	1	28
MICHELLE/2	5'9"	15 3/4"	32 1/2"	23 1/2"	34 1/4"	CHROME- ROUND	1	28
MICHELLE/3	5'9"	17 1/2"	32 1/2"	24"	34"	CHROME- ROUND	1	28
MICHELLE/4	5'9"	16"	33"	25 1/4"	36 1/4"	CHROME- ROUND	1	28
MICHELLE/5	3'9"	16"	33"	25 1/4"	36 1/4"	SITTING STOOL	1	33

**FLESHTONE
REALISTIC**

FEMALE MANNEQUINS



F/3X

F/4X

F/5X

F/9X

UNBREAKABLE MQ'S & WIGS

PRODUCT DESCRIPTION

ITEM	HEIGHT	SHOULDER	CHEST	WAIST	HIP	BASE	PACK	WEIGHT
F/3X	57"	15 3/4"	33"	24"	34"	CHROME-SQUARE	1	28
F/4X	57"	17 3/4"	33"	24"	34"	CHROME-SQUARE	1	28
F/5X	57"	17 3/4"	33"	24"	34"	CHROME-SQUARE	1	28
F/9X	57"	15 3/4"	33"	24"	34"	CHROME-SQUARE	1	28

POLYETHYLENE MANNEQUIN WIGS



8096/C

8096/Y

CY/8081P

CY/8194

FEMALE MANNEQUINS

**FLESHTONE
REALISTIC**



JOYCE/1

JOYCE/2

JOYCE/3

JOYCE SERIES & WIGS

PRODUCT DESCRIPTION

ITEM	HEIGHT	SHOULDER	CHEST	WAIST	HIP	BASE	PACK	WEIGHT
JOYCE/1	56"	17 1/3"	33"	23 2/3"	33"	CHROME- ROUND	1	28
JOYCE/2	59"	17 1/3"	33"	25 2/3"	33"	CHROME- ROUND	1	28
JOYCE/3	58"	17 1/3"	33"	25 2/3"	34"	CHROME- ROUND	1	28

POLYETHYLENE MANNEQUIN WIGS



T10

T11

T11B

S012B

R02

MANNEQUINS

MANNEQUINS

**MATTE & GLOSSY WHITE
ABSTRACT**

MALE MANNEQUINS



GLOSSY WHITE - (GW)

PRODUCT DESCRIPTION

ITEM	HEIGHT	SHOULDER	CHEST	WAIST	HIP	BASE	PACK	WEIGHT
SAM1-GW	6'1"	20 1/2"	40"	32"	38"	CHROME- ROUND	1	34
SAM1-MW	6'1"	20 1/2"	40"	32"	38"	CHROME- ROUND	1	34

GLOSSY WHITE Finish Available in CA warehouse ONLY

MATTE WHITE Finish Available in NJ warehouse ONLY

**MATTE & GLOSSY WHITE
ABSTRACT**

MALE MANNEQUINS



MATTE WHITE - (MW)

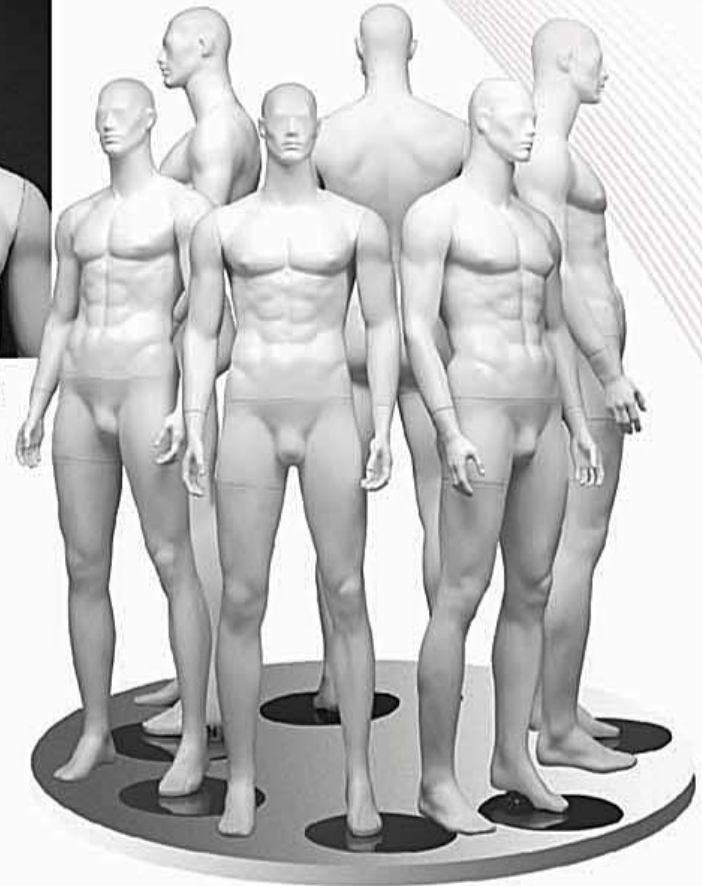

PRODUCT DESCRIPTION

ITEM	HEIGHT	SHOULDER	CHEST	WAIST	HIP	BASE	PACK	WEIGHT
SAM2-GW	6'2"	20 1/2"	42"	31"	38"	CHROME- ROUND	1	34
SAM2-MW	6'2"	20 1/2"	42"	31"	38"	CHROME- ROUND	1	34

GLOSSY WHITE Finish Available in CA warehouse ONLY

MATTE WHITE Finish Available in NJ warehouse ONLY

**MATTE WHITE
HEADLESS**

MALE MANNEQUINS



ERIC/1



ERIC/3

ERIC SERIES

PRODUCT DESCRIPTION

ITEM	HEIGHT	SHOULDER	CHEST	WAIST	HIP	BASE	PACK	WEIGHT
ERIC/1	5'8"	20 7/8"	38 1/2"	31"	37 3/4"	CHROME- ROUND	1	28
ERIC/2	5'8"	20 7/8"	38 1/2"	31"	37 3/4"	CHROME- ROUND	1	28
ERIC/3	5'8"	20 7/8"	38 1/2"	31"	37 3/4"	CHROME- ROUND	1	28

MALE MANNEQUINS



MIKE/1



MIKE/2



MIKE/3

MIKE SERIES

PRODUCT DESCRIPTION

ITEM	HEIGHT	SHOULDER	CHEST	WAIST	HIP	BASE	PACK	WEIGHT
MIKE/1	6'2"	20 7/8"	38 1/2"	31"	37 3/4"	CHROME- ROUND	1	35
MIKE/2	6'2"	20 7/8"	38 1/2"	31"	37 3/4"	CHROME- ROUND	1	35
MIKE/3	6'2"	20 7/8"	38 1/2"	31"	37 3/4"	CHROME- ROUND	1	35

**GLOSSY WHITE & GLOSSY BLACK
ABSTRACT**

**MATTE WHITE
INVISIBLE**

FEMALE & MALE MANNEQUINS



GM/F

GM/M

GHOST MANNEQUIN SERIES

PRODUCT DESCRIPTION

ITEM	HEIGHT	CHEST	WAIST	HIP	BASE	PACK	WEIGHT
GM/F	5'3"	33"	26"	36"	CHROME-SQUARE	1	33
GM/M	5'7"	41"	31"	41"	CHROME-SQUARE	1	36

FEMALE & MALE MANNEQUINS



UNI/F

UNI/M

FW/1

FM/1

FLEXIBLE ELBOW SERIES

PRODUCT DESCRIPTION

ITEM	HEIGHT	CHEST	WAIST	HIP	BASE	PACK	WEIGHT
UNI/F	5'11"	35"	25"	36"	CHROME-RECTANGULAR	1	28
UNI/M	6'1"	39"	28"	39"	CHROME-RECTANGULAR	1	30
FW/1	5'7"	41"	31"	41"	CHROME-ROUND	1	36
FM/1	6'2"	44"	34"	44"	CHROME-ROUND	1	36

FLESH TONE

BRAZILIAN HEADLESS



R4902B
BRAZILIAN FEMALE
HEADLESS PLUS SIZE
BODY WITH ARMS



R2204B
BRAZILIAN FEMALE
HEADLESS FULL
BODY WITH ARMS



9004B
BRAZILIAN FEMALE
HEADLESS FULL
BODY WITHOUT ARMS



1704B
BRAZILIAN FEMALE
LOWER BODY
- STRAIGHT LEG



9205B
BRAZILIAN FEMALE
LOWER BODY
- FOLDED LEG



R12B
BRAZILIAN FEMALE
SINGLE LEG FOR
SOCKS SELF STANDING

BRAZILIAN SERIES

PRODUCT DESCRIPTION

ITEM	HEIGHT	CHEST	WAIST	HIP	BASE	PACK	WEIGHT
R4902B	5'1"	40 1/2"	38 1/2"	44 1/2"	MANILLA-SQUARE	1	41
R2204B	5'4"	32"	26"	38"	MANILLA-SQUARE	1	38
9004B	5'4"	34"	26"	36"	MANILLA-SQUARE	1	34
1704B	4'	0	27"	38 1/4"	MANILLA-SQUARE	1	8
9205B	4'	0	29"	39"	MANILLA-SQUARE	1	8
R12B	26"	0	0	0	NO BASE	1	3

FEMALE MANNEQUINS

AFRICAN AMERICAN MANNEQUINS

MATTE BROWN
REALISTIC



DARRELL



DONNA

PRODUCT DESCRIPTION

ITEM	HEIGHT	SHOULDER	CHEST	WAIST	HIP	BASE	PACK	WEIGHT
DARRELL	6'1"	22"	39"	31"	37"	CHROME-ROUND	1	30
DONNA	5'9"	18"	33"	24"	35"	CHROME-ROUND	1	28

**GLOSSY WHITE
ABSTRACT**

CHILDREN'S MANNEQUIN

CHILDREN'S MANNEQUIN

**FLESH-TONE & WHITE
UNISEX**

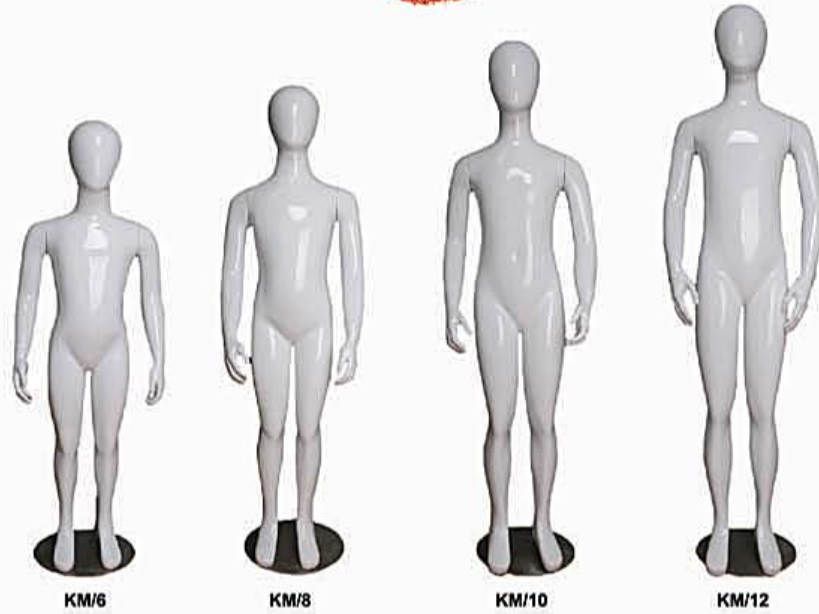

CS/1 REX-BOY(B1) CS/1 REX-GIRL(B4)

**WHITE
- WHITE FABRIC COVERED FOAM
- BENDABLE LIMBS & FINGERS**



B1 B4

WIG ONLY

CHILDREN'S SERIES

PRODUCT DESCRIPTION

ITEM	HEIGHT	CHEST	WAIST	HIP	BASE	PACK	WEIGHT
KM/6	3'	25"	22"	25"	CHROME- ROUND	1	22
KM/8	4'5"	26"	23"	27"	CHROME- ROUND	1	22
KM/10	4'9"	26"	24"	30"	CHROME- ROUND	1	25
KM/12	5'2"	26"	24"	30"	CHROME- ROUND	1	26

CHILDREN'S SERIES

PRODUCT DESCRIPTION

ITEM	HEIGHT	CHEST	WAIST	HIP	BASE	PACK	WEIGHT
CS/1 REX- UNISEX DESIGN	3'5"	22"	20"	24"	GLASS- RECT.	2	20
FLC3- UNISEX DESIGN FOR AGES 3 - 4 YRS OLD	33 1/2"	17 3/4"	17"	19"	CHROME- SQUARE	2	10
FLC5- UNISEX DESIGN FOR AGES 5 - 6 YRS OLD	39 1/2"	21"	20 1/2"	21 1/2"	CHROME- SQUARE	2	10
FLC7- UNISEX DESIGN FOR AGES 7 - 8 YRS OLD	42"	21"	20 1/2"	23"	CHROME- SQUARE	2	10
FLC9- UNISEX DESIGN FOR AGES 9 - 10 YRS OLD	47"	22"	21"	24"	CHROME- SQUARE	2	10

LINEN WHITE BODY FORMS



LW/F



LW/M



BASE SOLD SEPARATLY

BASE PAGE : 38

PRODUCT DESCRIPTION

ITEM	HEIGHT	SHOULDER	CHEST	WAIST	HIP	PACK	WEIGHT
LW/F	FORM ONLY 37"	16"	35"	25"	34"	1	18
LW/M	FORM ONLY 40"	18"	38"	31"	35"	1	21

CREAM BODY FORMS



BFF-3/4/C-M

- 3/4 JERSEY COVERED MOLDED POLYURETHANE BODY FOAM
- BLACK METAL NECK BLOCK
- HEIGHT ADJUSTABLE
- BASE POLE LENGTH: 48"
- BASE SIZE: 15"(L) x 13"(W) SQB/1 BASE



BFM-3/4/C-M

- 3/4 JERSEY COVERED MOLDED POLYURETHANE BODY FOAM
- BLACK METAL NECK BLOCK
- HEIGHT ADJUSTABLE
- BASE POLE LENGTH: 48"
- BASE SIZE: 15"(L) x 13"(W) SQB/1 BASE

PRODUCT DESCRIPTION

ITEM	HEIGHT	CHEST	WAIST	HIP	BASE	PACK	WEIGHT
BFF-3/4/C-M	FORM ONLY 31"	34"	25"	34 1/2"	BRUSHED- CHROME	1	38
BFM-3/4/C-M	FORM ONLY 33"	39"	31"	39 1/2"	BRUSHED- CHROME	1	40

CREAM BODY FORMS



BFF/C-M

- 3/4 JERSEY COVERED MOLDED POLYURETHANE BODY FOAM
- METAL NECK BLOCK & BRUSHED CHROME BASE(SQB/1)
- HEIGHT ADJUSTABLE
- BASE POLE LENGTH: 48"
- BASE SIZE: 15"(L) x 13"(W)



BFM/C-M



BFF/C-W

- 3/4 JERSEY COVERED MOLDED POLYURETHANE BODY FOAM
- MAPLE WOOD NECK BLOCK & TRIPOD WOOD BASE (WTB-M)
- HEIGHT ADJUSTABLE
- TRIPOD WOOD BASE



BFM/C-W

PRODUCT DESCRIPTION

ITEM	HEIGHT	SHOULDER	CHEST	WAIST	HIP	BASE	PACK	WEIGHT
BFF/C-M	FORM ONLY 29"	15"	46"	25"	36"	BRUSHED CHROME	1	20
BFF/C-W	FORM ONLY 29"	15"	46"	25"	36"	MAPLE- TIRPOD	1	20
BFM/C-M	FORM ONLY 33"	19"	48"	33"	39"	BRUSHED CHROME	1	20
BFM/C-W	FORM ONLY 33"	19"	48"	33"	39"	MAPLE- TIRPOD	1	20

BLACK BODY FORMS



- 3/4 JERSEY COVERED MOLDED POLYURETHANE BODY FOAM
- METAL NECK BLOCK & BRUSHED CHROME BASE (SQB/1)
- HEIGHT ADJUSTABLE
- BASE POLE LENGTH: 48"
- BASE SIZE: 15"(L) x 13"(W)

BFF/B-M



BFM/B-M



- 3/4 JERSEY COVERED MOLDED POLYURETHANE BODY FOAM
- MAPLE WOOD NECK BLOCK & TRIPOD WOOD BASE (WTB-B)
- HEIGHT ADJUSTABLE
- TRIPOD WOOD BASE

BFF/B-W



BFM/B-W

PRODUCT DESCRIPTION

ITEM	HEIGHT	SHOULDER	CHEST	WAIST	HIP	BASE	PACK	WEIGHT
BFF/B-M	FORM ONLY 29"	15"	46"	25"	36"	BRUSHED CHROME	1	20
BFF/B-W	FORM ONLY 29"	15"	46"	25"	36"	MAPLE- TRIPOD	1	20
BFM/B-M	FORM ONLY 33"	19"	48"	33"	39"	BRUSHED CHROME	1	20
BFM/B-W	FORM ONLY 33"	19"	48"	33"	39"	MAPLE- TRIPOD	1	20

BODY FORMS BASE



ITB/1

HEAVY CAST IRON BASE
7/8" DIA. 48" UPRIGHT
FINISH : RAW METAL
PACK : 1
WEIGHT : 15 LBS
MATERIAL : STEEL



DMB/1-CH

CHROME DRESSMAKER BASE
7/8" DIA. 48" UPRIGHT
PACK : 1
WEIGHT : 16 LBS
MATERIAL : STEEL



DMB/1-BC

BRUSHED BLACK DRESSMAKER BASE
7/8" DIA. 48" UPRIGHT
PACK : 1
WEIGHT : 7 LBS
MATERIAL : ALUMINUM



DMB/1-YC

COPPER DRESSMAKER BASE
7/8" DIA. 48" UPRIGHT
PACK : 1
WEIGHT : 9 LBS
MATERIAL : ALUMINUM



TPB/1

TRIPOD BASE
7/8" DIA. 48" UPRIGHT
FINISH : MATTE BLK.
PACK : 1
WEIGHT : 9 LBS
MATERIAL : STEEL



SQB/1

MANNEQUIN FLOOR STAND BASE
7/8" DIA. 48" UPRIGHT
BASE : 13" x 15"
FINISH : BRUSHED CHROME
PACK : 2
WEIGHT : 27 LBS



WTB-M

WOOD TRIPOD BASE
TOTAL HEIGHT : 48"
FINISH : MAPLE
PACK : 2
WEIGHT : 9 LBS



WTB-B

WOOD TRIPOD BASE
TOTAL HEIGHT : 48"
FINISH : BLACK
PACK : 2
WEIGHT : 9 LBS



FMB/4

ADJUSTABLE HANGING FORM FLOOR STAND
ADJUSTABLE FROM 49" TO 78"
ARM LENGTH: 6"
BASE : 12" x 14"
FINISH : BRUSHED & CLEAR COAT
PACK : 1
WEIGHT : 16 LBS

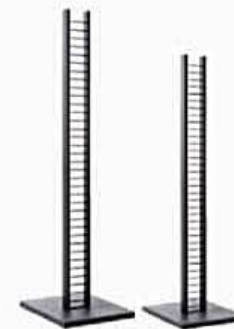

ML73-MAB

MINI-LADDER FLOOR STAND- 73"H
BASE : 12" x 15" x1"(H)
FINISH : MATTE BLK.
PACK : 1
WEIGHT : 32 LBS

ML55-MAB

MINI-LADDER FLOOR STAND- 55"H
BASE : 12" x 15" x1"(H)
FINISH : MATTE BLK
PACK : 1
WEIGHT : 27 LBS

**CREAM
BODY FORMS**



BFHF/C-W



BFHF/C-M



BFHM/C-W



BFHM/C-M



BFB/C-4



BFB/C-8



BFB/C-12

PRODUCT DESCRIPTION

ITEM	HEIGHT	CHEST	WAIST	BASE	PACK	WEIGHT
BFHF/C-W	24"	37 3/4"	26 1/4"	MAPLE- ROUND	1	10
BFHF/C-M	24"	37 3/4"	26 1/4"	METAL- ROUND	1	13
BFHM/C-W	24"	37 3/4"	26 1/4"	MAPLE- ROUND	1	11
BFHM/C-M	24"	39 1/3"	34"	MAPLE- ROUND	1	14
BFB/C-4	16"	22 1/2"	20"	MAPLE- TRIPOD	1	8
BFB/C-8	21 3/4"	26 3/4"	22 3/4"	MAPLE- TRIPOD	1	9
BFB/C-12	27"	29"	26 1/3"	MAPLE- TRIPOD	1	10

- JERSEY COVERED MOLDED POLYURETHANE FOAM
- MAPLE WOOD NECK BLOCK & BASE
- METAL NECK BLOCK & BRUSHED CHROME BASE

COUNTERTOP MANNEQUINS

GLOSSY WHITE



HM/FHG
WITH ARMS
AND HEAD
- POST HEIGHT: 33 1/2"



HM/MHG
WITH ARMS
AND HEAD
- POST HEIGHT: 33 1/2"

MATTE WHITE



HM/F
COMES WITH ARMS
AND SHOULDER CAPS
- POST HEIGHT: 33 1/2"



SHOULDER CAPS



HM/M
COMES WITH ARMS
AND SHOULDER CAPS
- POST HEIGHT: 33 1/2"



SHOULDER CAPS

PRODUCT DESCRIPTION

ITEM	HEIGHT	CHEST	WAIST	BASE	PACK	WEIGHT
HM/FHG	40"	32"	24"	CHROME- SQUARE	1	22
HM/MHG	40"	34"	29"	CHROME- SQUARE	1	22
HM/F	26"	32 1/4"	24 1/4"	CHROME- ROUND	1	20
HM/M	25 1/2"	37 7/8"	29 3/8"	CHROME- ROUND	1	20

MANNEQUIN PARTS - LEG FORMS & HEADS

GLOSSY WHITE/BLACK

STRAIGHT LEG



AHM-01
HEIGHT : 49"
INSEAM : 33"
HIP : 34"
PACK : 1
WEIGHT : 15

FOLDED LEG



AHM-02
HEIGHT : 46 1/2"
INSEAM : 32"
HIP : 34"
PACK : 1
WEIGHT : 15

FEMALE HEAD



PDHA-FG1
HEIGHT : 19 1/4"
PACK : 1
WEIGHT : 3

MALE HEAD



PDHA-MG1
HEIGHT : 17 1/4"
PACK : 1
WEIGHT : 3



XS57-B
XS57-W
PLASTIC FEMALE SHIRT CLOTHING FORM
INCLUDES HOOK
OPEN HOLLOW BACK SHELL
BLACK / WHITE
PACK : 25
WEIGHT : 35



XS67-B
XS67-W
PLASTIC FEMALE SHIRT CLOTHING FORM
INCLUDES HOOK
OPEN HOLLOW BACK SHELL
BLACK / WHITE
PACK : 25
WEIGHT : 35



XS77-B
XS77-W
PLASTIC FEMALE SHIRT CLOTHING FORM
INCLUDES HOOK
OPEN HOLLOW BACK SHELL
BLACK / WHITE
PACK : 25
WEIGHT : 35

MANNEQUIN PARTS - COUNTERTOP

CLEAR & FLESH TONE



CLAIRE 4
HEIGHT : 31 1/2"
CHEST : 33"
WAIST : 23 3/4"
HIP : 34 1/2"
PACK : 1
WEIGHT : 8



CLAIRE 5
HEIGHT : 16"
CHEST : 33"
PACK : 2
WEIGHT : 8



CLAIRE 5 BASE
BASE : CHROME- SQUARE
PACK : 1
WEIGHT : 6



XS147-B
XS147-W
PLASTIC FEMALE UPPER/CRYSTAL BASE
OPEN HOLLOW BACK SHELL
BLACK / WHITE
PACK : 25
WEIGHT : 60



299-B
299-W
PLASTIC FEMALE HANGING HIP FORM
INCLUDES HOOK
OPEN HOLLOW BACK SHELL
BLACK / WHITE
PACK : 25
WEIGHT : 20



XS417
PLASTIC FEMALE FREE STANDING BRA FORM
INCLUDES BASE
OPEN HOLLOW BACK SHELL
CLEAR
PACK : 25
WEIGHT : 40



XS517
PLASTIC FEMALE SHIRT CLOTHING FORM
INCLUDES HOOK
OPEN HOLLOW BACK SHELL
CLEAR
PACK : 25
WEIGHT : 13



CLAIRE CALF
HEIGHT : 13"
PACK : 1
WEIGHT : 4



CLAIRE KNEE
HEIGHT : 19 1/3"
PACK : 1
WEIGHT : 4



CLAIRE LEG1
HEIGHT : 27 1/2"
PACK : 1
WEIGHT : 4



CLAIRE LEG2
HEIGHT : 30"
PACK : 1
WEIGHT : 4



R12B
HEIGHT : 26"
PACK : 1
WEIGHT : 3



XS48-B
XS48-W
PLASTIC MALE TORSO FORM
INCLUDES HOOK
OPEN HOLLOW BACK SHELL
BLACK / WHITE
PACK : 25
WEIGHT : 23



XS158-B
XS158-W
PLASTIC MALE TORSO FORM
INCLUDES HOOK
OPEN HOLLOW BACK SHELL
BLACK / WHITE
PACK : 25
WEIGHT : 20



298-B
298-W
PLASTIC MALE HANGING HIP FORM
INCLUDES HOOK
OPEN HOLLOW BACK SHELL
BLACK / WHITE
PACK : 25
WEIGHT : 20



HD-W
HEIGHT : 11"
PACK : 2
WEIGHT : 3



HD-M
HEIGHT : 11"
PACK : 1
WEIGHT : 3



FT-C
HEIGHT : 9"
BASE : CHROME- ROUND
PACK : 6
WEIGHT : 7



FT-W
HEIGHT : 11"
BASE : CHROME- ROUND
PACK : 6
WEIGHT : 7



FT-M
HEIGHT : 14"
BASE : CHROME- ROUND
PACK : 6
WEIGHT : 7



XS198-B
XS198-W
PLASTIC MALE UPPER/CRYSTAL BASE
OPEN HOLLOW BACK SHELL
BLACK / WHITE
PACK : 25
WEIGHT : 60



555-W
PLASTIC BIG KIDS HALF ROUND FORM
INCLUDES HOOK
OPEN HOLLOW BACK SHELL
WHITE
PACK : 25
WEIGHT : 37



155-W
PLASTIC KIDS HALF ROUND FORM
INCLUDES HOOK
OPEN HOLLOW BACK SHELL
WHITE
PACK : 25
WEIGHT : 37

Aluminum Material

GRAND DISPLAYER



- 01 · KP-L2137PC (x5)
- 02 · KD-947P (x2)
- 03 · KD-940P (x2)

- 04 · KD-962P (x2)
- 05 · KD-915P (x10)
- 06 · KD-980LP / KD-980MP (x3)

- 07 · KD-741P / KD741LPS (x9)
- 08 · KD-900P (x32)
- 09 · KD-920P (x20)

Klamp Pole

FREE MOUNT DISPLAYERS

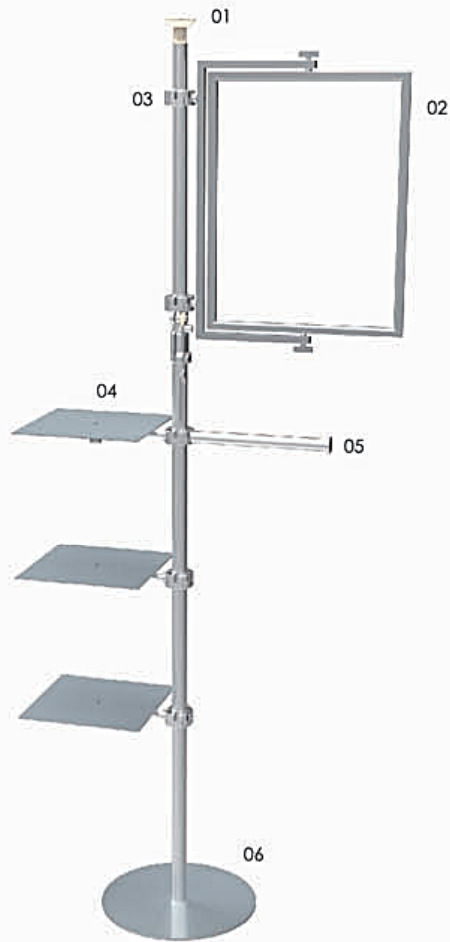

▲ SINGLE

- 01 · KP-L2137PC (x1)
- 02 · KD-850S (x1)
- 03 · KD-900P (x5)
- 04 · KD-940P (x3)
- 05 · KD-981P (x1)
- 06 · KD-R48P (x1)

Aluminum Material

FREE MOUNT DISPLAYERS



SINGLE ▲

- 01 · KP-L2137PC (x1)
- 02 · KD-935P (x2)

Aluminum Material
FREE MOUNT DISPLAYERS

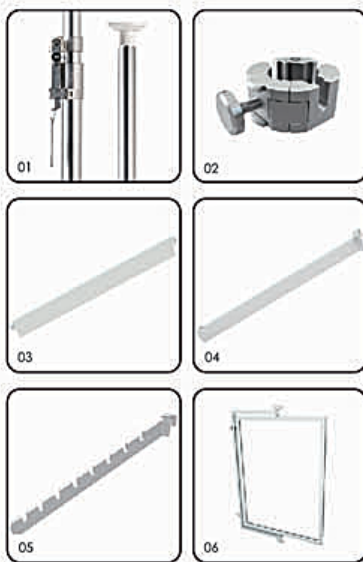
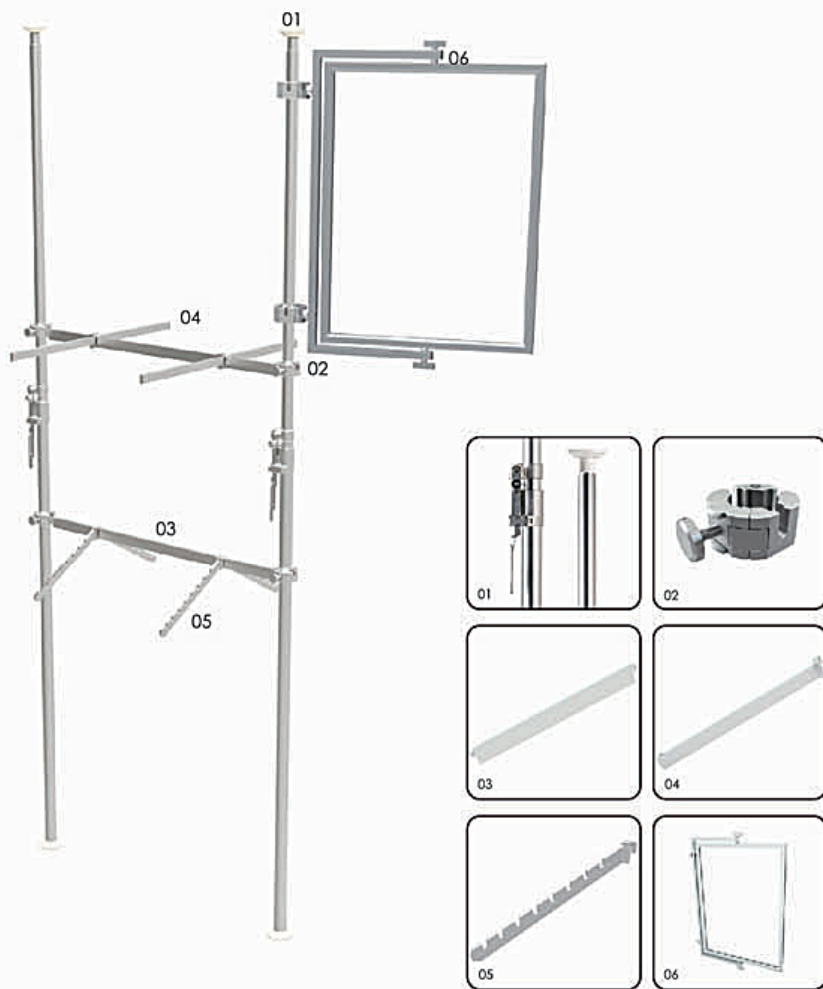

▲ DOUBLE

- | | |
|----------------------|-------------------|
| 01 · KP-L2137PC (x2) | 04 · KD-961P (x4) |
| 02 · KD-900P (x4) | 05 · KD-962P (x4) |
| 03 · KD-960LP (x2) | 06 · KD-850S (x1) |

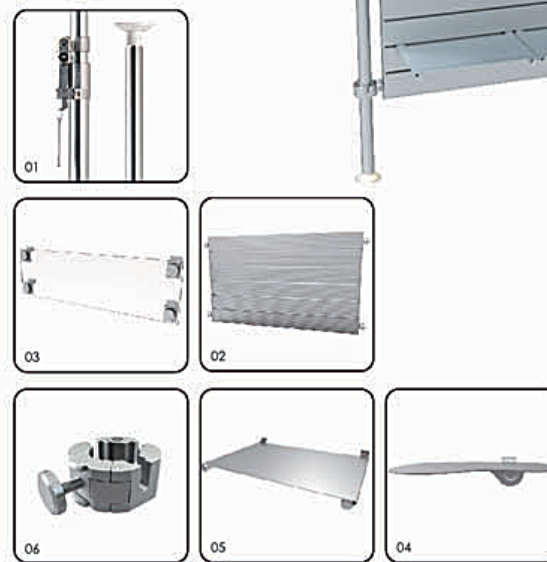

TRIPLE ▲

- | | |
|----------------------|--------------------|
| 01 · KP-L2137PC (x3) | 04 · KD-502P (x21) |
| 02 · KD-500P (x6) | 05 · KD-503P (x10) |
| 03 · KD-501P (x4) | 06 · KD-900P (x18) |



Klamp Pole COMPONENTS

ACTUAL LOOK



▲ **KP-L2137PC**
KP-X15P, KP-X20P

82 1/2" ~ 145 1/2" POLE
PK 2 / WT 21 LBS.
EXT. KUPOLE EXTENSION-4'9"
PK 1 / WT 3 LBS.
EXT. KUPOLE EXTENSION-6'5"
PK 1 / WT 2 LBS.



▲ **KD-900P**

DONUT
KLAMP TUBES DIA.
1 1/2" - 1 3/4"
ATTACHES UP TO
3 ACCESSORIES TO TUBE
PK 1 / WT 1 LBS.



▲ **KD-F95P**

KUPOLE FEMALE SOCKET
MOUNTS ON TOP OF KUPOLE
AND ATTACHES ON KD-751P
PK 1 / WT 1 LBS.



▲ **KD-R48P**

DISC STEEL BASE
DIA. 19"
PK 1 / WT 2 LBS.



▲ **KCP-700P**

CONVI CLAMP
THE JAW GRIP
FROM 1/2" TO 3/5"
ATTACH ACCESSORIES TO KUPOLE.
SPAN OR TUBE 1 1/2" TO 1 3/4"
PK 1 / WT 1 LBS.



▲ **KD-910P**

PANEL HOLDER
ATTACH PANELS OR SHELVES
TO KD-900P
1/3" THICK. MOUNTS ONTO
KD-900
PK 2 / WT 1 LBS.



▲ **KD-981P**

**ROUND FACEOUT WITH
HANGER STOP**
16"(L)
MOUNTS ON KD-900P
MAXIMUM LOAD 9 LBS
PK 2 / WT 3 LBS.



▲ **KD-982P**

WALL MOUNT
DIA. 1"
ATTACHES KD-980SP TO
CEILING OR WALL
PK 2 / WT 1 LBS.



▲ **KD-920P**

ROTATING PANEL HOLDER
ATTACH PANELS OR SHELVES
TO KD-900P
ACCEPTS MATERIAL
UP TO 1/2" THICK
PK 2 / WT 1 LBS.



▲ **KD-980LP**

ROUND HANGRAIL
DIA. 1 1/3"
41 1/2"(L)
MOUNTS ON KD-900P
MAXIMUM LOAD 44 LBS
PK 2 / WT 4 LBS.

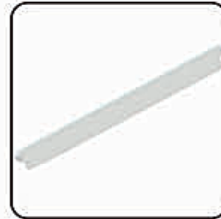

▲ **KD-960MP**

RECTANGULAR CROSSBAR
31 1/2"(L)
MAXIMUM LOAD 55 LB
PK 2 / WT 5 LBS.



▲ **KD-915P**

TIDY PANEL HOLDER
ATTACH PANELS OR SHELVES
UP TO 1/2" THICK. MOUNTS
ONTO KD-900P
PK 2 / WT 1 LBS.



▲ **KD-980MP**

ROUND HANGRAIL
31 1/2"(L)
MAXIMUM LOAD 55 LBS
PK 2 / WT 3 LBS.



▲ **KD-961P**

**RECTANGULAR CROSSBAR
FACEOUT**
16"(L)
FOR USE WITH KD-960
MAXIMUM LOAD 7 LBS
PK 2 / WT 5 LBS.



▲ **KCP-360P**

ALI KLAMP
MOUNTING ON KS-020
PK 2 / WT 1 LBS.



▲ **KD-980SP**

ROUND HANGRAIL
DIA. 1 1/3"
LENGTH: 16"
MAX LOAD: 65 LBS
REQUIRES KD-900
PK 2 / WT 3 LBS.



▲ **KD-962P**

LAYER FACEOUT
14 1/2"(L)
FOR USE WITH KD-960
MAXIMUM LOAD 7 LBS
PK 2 / WT 5 LBS.



▲ **KD-816P**

SQUARE CLIP
MOUNTING ON KD-900P
2"(W) X 3 1/2"(H)
PK 2 / WT 1 LBS.

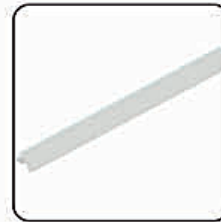

▲ **KD-960LP**

RECTANGULAR CROSSBAR
41 1/2"(L)
MOUNTS KD-900P
MAXIMUM LOAD 44 LBS
PK 2 / WT 3 LBS.

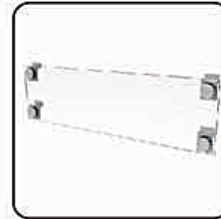

▲ **KD-501P**

**POSTER HOLDER
(W/O PANEL POSTER)**
SET OF 4
1"(W) X 1 3/4"(L) X 3/4"(T)
MOUNTING ON KD-500P
PK 1 / WT 1 LBS.



▲ **KD-812P**

U HOOK
1 3/4" DEPTH
MOUNTING ON
KCP-700, KD-900, KD-C05
PK 2 / WT 1 LBS.

Klump Pole COMPONENTS



▲ **KD-990P**

L BRACKET SHELF HOLDER
SET OF 2
6 3/4"(W) X 1 1/2"(D) X 1 1/2"(H)
MOUNTING ON KD-900P
PK 2/ WT 2 LBS.



▲ **KD-942P**

BOOK SHELF
9 3/4"(W) X 7 3/4"(D) X 9 3/4"(H)
MOUNTING ON KD-900
MAXIMUM LOAD 20LBS
PK 2/ WT 5 LBS.



▲ **KD-943P**

CATALOGUE SHELF
9 3/4"(W) X 3 1/3"(D) X 9 3/4"(H)
MOUNTING ON KD-900
MAXIMUM LOAD 20LBS
PK 2/ WT 5 LBS.



▲ **KD-751P**

SIGN FRAME TRIPOD/CEILING
GRAPHIC SIZE:
21 1/2"(W) X 27 1/2"(H)
ACCEPTS MATERIAL UP TO 1/2" T
MOUNTING ON KCP-700 OR KD-F95P
PK 1/ WT 3 LBS.



▲ **KD-752P**

SIGN FRAME TRIPOD/CEILING
GRAPHIC SIZE:
10 1/2"(W) X 13 3/4"(H)
ACCEPTS MATERIAL 1/4" THICK
MOUNTING ON KCP-700 OR KD-F95P
PK 1/ WT 3 LBS.



▲ **KD-850S**

SIGN FRAME SIDEMOUNT
GRAPHIC SIZE:
21 1/2"(W) X 27 1/2"(H)
ACCEPTS MATERIAL UP TO 1/4" THICK
REQUIRES 2 KD-900P
PK 1/ WT 3 LBS.

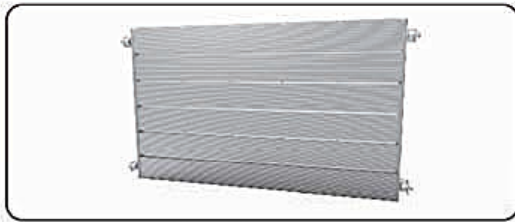

▲ **KD-500P**

ALUMINUM SLAT PANEL
41 3/4"(W) X 23 1/2"(L) X 3/4"(T)
MOUNTING ON 4 KD-900P
PK 2/ WT 25 LBS.



▲ **KD-602P**

VIVI-RING WITH HANGER ROD
ROTATING CLAMP WITH
4 SCREWED RODS
CLAMP TUBES DIA. 1 3/4"
ROD SIZE: DIA. 1/2"
PK 2/ WT 7 LBS.



▲ **KD-603P**

VIVI-RING WITH HANGER ROD
ROTATING CLAMP WITH
8 SCREWED RODS
CLAMP TUBES DIA. 1 1/2" TO 1 3/4"
ROD SIZE: DIA. 3/4"
PK 2/ WT 7 LBS.



▲ **KD-965P**

SPIRAL HANGER
31 1/2"(W) X 51 1/2"(H)
FOR USE WITH KD-960
REQUIRES 2 KD-900 OR KD-C05
PK 1/ WT 7 LBS.



ACTUAL LOOK



▲ **KD-503P**

DISPLAY SHELF
17 3/4"(W) X 11 3/4"(D)
MOUNTING ON KD-500P
PK 1/ WT 4 LBS.



▲ **KD-940P**

DISPLAY SHELF
15" SQUARE
14 1/2" ADJUSTABLE EXTENSION
MOUNTING ON KD-900P OR
MAXIMUM LOAD 10 LB
PK 1/ WT 3 LBS.



▲ **KD-947P**

ROUND SHELF
DIA. 13"
11 1/2" ADJUSTABLE EXTENSION
MOUNTING ON KD-900P
MAXIMUM LOAD 10 LB
PK 1/ WT 3 LBS.



▲ **KD-741P**

SHELF WITH BENT EDGES
30"(L) X 15"(D)
MAXIMUM LOAD 66 LBS.
PK 1/ WT 7 LBS.



▲ **KD-741LP-S**

SHELF WITH BENT EDGES
40"(L) X 15"(D)
MAXIMUM LOAD 55 LBS
PK 1/ WT 5 LBS.



▲ **KD-502P**

SHOE PANEL
9 3/4"(W) X 5"(D)
ADJUSTABLE ANGLE:
15, 30 OR 180 DEGREE
MOUNTING ON KD-500P
PK 1/ WT 1 LBS.

GLOSSY WHITE / CHROME
ELDURA SYSTEM - ELD



NEW PRODUCT

ELDURA WALL SYSTEM COMPONENTS:

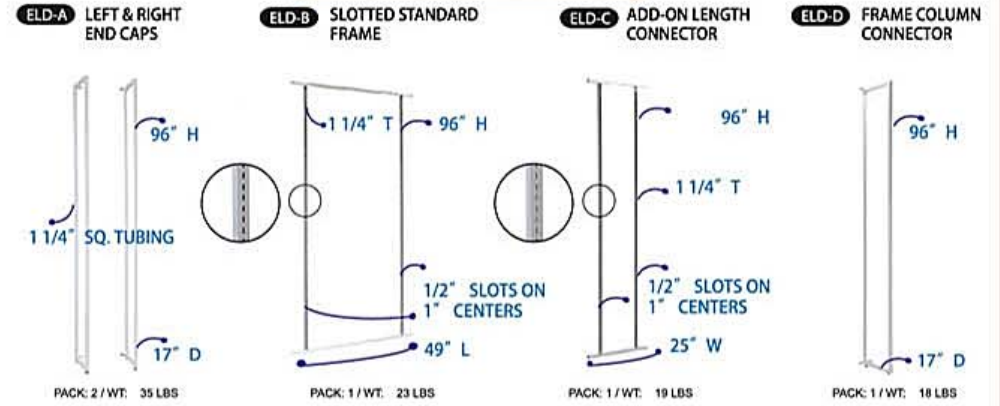

PERSONALIZE ACCORDING TO YOUR DISPLAY NEEDS:

APPLIED HARDWARE:

OPTION 1 : 4'- 4" WALL SET-UP **OPTION 2 : 6'- 7" WALL SET-UP**



OPTION 3 : 8'- 7" WALL SET-UP **OPTION 4 : 10'- 10" WALL SET-UP**

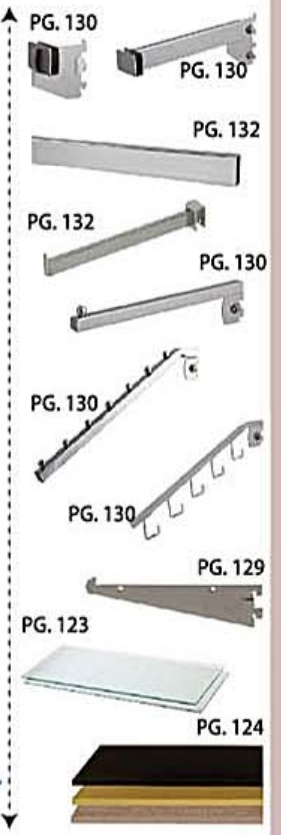
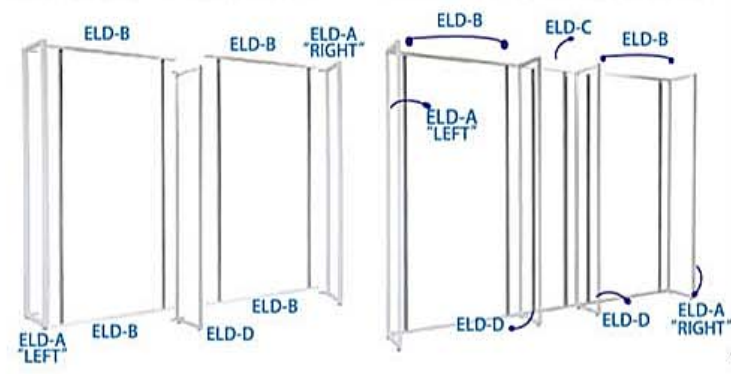

ELDURA SYSTEMS

ELDURA SYSTEMS

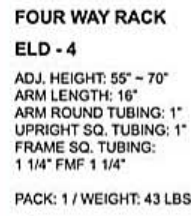

Matte Black Finish
PIPE RACK SYSTEM - PL



TABLE PRODUCTS







TABLES CAN BE NESTED
OR USED SEPARATELY

PL-TLBL
NESTING TABLE LARGE
- 60"(W) x 32"(D) x 30"(H)
- PACK 1 / WT 65 LBS

PL-TLBS
NESTING TABLE SMALL
- 47 5/8"(W) x 23 5/8"(D) x 24"(H)
- PACK 1 / WT 45 LBS

MELAMINE WOOD SHELVING

	WS1224-W - 12" x 24" WS1248-W - 12" x 48" WS1448-W - 14" x 48"	WHITE WHITE WHITE	PK : 8 / WT : 47 LBS PK : 4 / WT : 47 LBS PK : 4 / WT : 54 LBS
	WS1224-B - 12" x 24" WS1248-B - 12" x 48" WS1448-B - 14" x 48"	BLACK BLACK BLACK	PK : 8 / WT : 47 LBS PK : 4 / WT : 47 LBS PK : 4 / WT : 54 LBS
	WS1224-M - 12" x 24" WS1248-M - 12" x 48" WS1448-M - 14" x 48"	MAPLE MAPLE MAPLE	PK : 8 / WT : 47 LBS PK : 4 / WT : 47 LBS PK : 4 / WT : 54 LBS
	WS1224-RW - 12" x 24" WS1248-RW - 12" x 48" WS1448-RW - 14" x 48"	HICKORY HICKORY HICKORY	PK : 8 / WT : 47 LBS PK : 4 / WT : 47 LBS PK : 4 / WT : 54 LBS

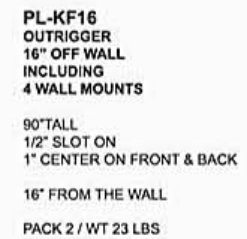

PL-BASE1
OUTRIGGER BASE- SMALL
24"L x 22"W x 4"H
BLACK MELAMINE FINISH
PACK 1 / WT 18 LBS

PL-BASE2
OUTRIGGER BASE- LARGE
47"L x 22"W x 4"H
BLACK MELAMINE FINISH
PACK 1 / WT 28 LBS

GREAT TO
DISPLAY SHOES

Matte Black Finish
PIPE RACK SYSTEM - PL

Matte Black Finish
PIPE RACK SYSTEM - PL

TWO WAY RACK



PL-K2
HEIGHT :
ADJ. 48" - 72"
BASE :
24 1/2" x 18 1/2"
ARMS :
16" LONG
PACK 1 / WT 35 LBS

FOUR WAY RACK

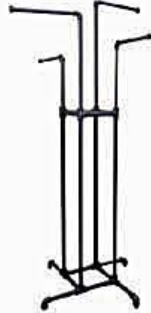

PL-K4
HEIGHT :
ADJ. 48" - 72"
BASE :
30" x 30"
ARMS :
16" LONG
PACK 1 / WT 54 LBS

BALLET BAR RACK

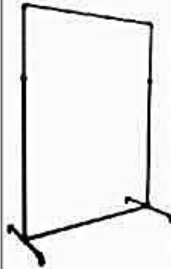

PL-KBB
HEIGHT :
ADJ. 48" - 72"
BASE :
48" x 23 1/2"
WIDTH :
48"
PACK 1 / WT 31 LBS

TWO-TIER RACK WITH SHELVES



PL-STEP
64"(L) x 24"(W) x 64"(H)
1ST TIER ARM : 20"
2ND TIER ARM : 26 3/4"
INCLUDES 2 LOCKING
& 2 W/O LOCKING
PACK 1 / WT 65 LBS

ADJUSTABLE TRAY DISPLAYER



PL-WT1
24"(L) x 24"(W) x 52"(H)
ADJ. TRAY ROTATES:
45 OR 90 DEGREES
TRAY DIMENSIONS:
17"(L) x 10"(W) x 3"(H)
PACK 1 / WT 36 LBS

USE FOR SLATWALL MERCHANDISERS



DOUBLE BALLET BAR RACK



PL-DBB
HEIGHT :
ADJ. 50" - 72"
LENGTH :
48"
WIDTH :
21"
PACK 1 / WT 54 LBS

H RACK

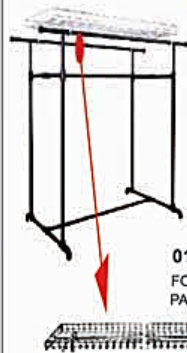

RACK ONLY
PL-KH
HEIGHT :
ADJ. 48" - 72"
BASE :
48" x 30"
WIDTH :
48"
PACK 1 / WT 69 LBS

01-008CH
FOLDING TOP BASKET
PACK 1 / WT 16 LBS

BALLET BAR WOOD BASE



BASE ONLY
PL-KBB-BASE
LENGTH :
51 1/2"
WIDTH :
23 1/2"
PACK 1 / WT 5 LBS

3" HANGTRAIL BRACKET



PL-CR3
LENGTH : 3"
PACK 25 / WT 14 LBS

5" HANGRAIL



PL-5CH
24"(L) x 5"(W)
FOR SLATWALL
PACK 4 / WT 8 LBS

12" FACEOUT



PL-SW12
LENGTH : 12"
FOR SLATWALL
PACK 25 / WT 24 LBS

36" ROUNDTRACK INCLUDING CASTERS



PL-RR
HEIGHT :
46"
BASE :
42" x 42"
PACK 1 / WT 48 LBS

HALF ROUND RACK

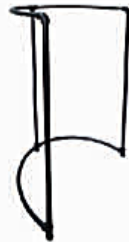

PL-HR
HEIGHT :
54"
BASE :
35" x 35"
PACK 1 / WT 23 LBS

TRIPOD BASE FOR BODY FORMS



TPB/1
HEIGHT :
48"
USED TO DISPLAY
BODY FORMS
PACK 1 / WT 9 LBS

12" HANGRAIL BRACKET



PL-CR12
LENGTH : 12"
PACK 25 / WT 22 LBS

12" HANGRAIL



PL-12CH
24"(L) x 12"(W)
FOR SLATWALL
PACK 10 / WT 30 LBS

5 HOOK FACEOUT



PL-5H
LENGTH : 16 1/2"
FOR SLATWALL
PACK 25 / WT 24 LBS

12" FACEOUT



PL-RDW12
LENGTH : 12"
PACK 25 / WT 22 LBS

RECTANGULAR TUBING



RE4-MAB
48"(L) x 1/2"(W) x 1 1/2"(H)
PACK 10 / WT 36 LBS

RECTANGULAR TUBING



RE2-CH
24"(L) x 1/2"(W) x 1 1/2"(H)
PACK 10 / WT 15 LBS

6 BALL FACEOUT



PL-6B
LENGTH : 16 1/2"
FOR SLATWALL
PACK 25 / WT 24 LBS

Matte Black Finish
PIPE RACK SYSTEM - PL

Matte White Finish
PIPE RACK SYSTEM - PL

LARGE GARMENT RACK w/ WOOD BASE



PL-MSY1
42"(L) x 18"(W) x 50"-65"(H)
PACK 1 / WT 56 LBS

PIPELINE MIRROR STAND



PL-MR
FRAME : 23"(W) x 69"(H)
MIRROR : 20"(W) x 60"(H)
PACK 1 / WT 70 LBS

SMALL GARMENT RACK w/ WOOD BASE



PL-MSY2
28"(L) x 18"(W) x 50"-65"(H)
PACK 1 / WT 51 LBS

3-PIECE NESTING END TABLE



PL-ST1 16"(L) x 16"(W) x 30"(H)
PACK 1 / WT 28 LBS

PL-ST2 16"(L) x 16"(W) x 36"(H)
PACK 1 / WT 30 LBS

PL-ST3 16"(L) x 16"(W) x 42"(H)
PACK 1 / WT 33 LBS

TWO WAY RACK



FOUR WAY RACK



BALLET BAR RACK



3" CASTERS NON BRAKES



3" CASTERS WITH BRAKES



NESTING TABLE LARGE/SMALL



**TABLES CAN BE NESTED
OR USED SEPARATELY**

PL-TLBL(MW)
NESTING TABLE LARGE
- 60"(W) x 32"(D) x 30"(H)
- PACK 1 / WT 65 LBS

PL-TLBS(MW)
NESTING TABLE SMALL
- 47 5/8"(W) x 23 5/8"(D) x 24"(H)
- PACK 1 / WT 45 LBS

**SATIN NICKEL FINISH
SLOTTED SYSTEM - AK**



WALL STANDARD



AK-WS
WALL STANDARD
90"(H) X 12"(D)
1" SLOT ON 2" CENTER
TUBING: 2" X 2"
PACK: 2 / WT: 35

SATIN NICKEL FINISH



SINGLE DISPLAYER WITH CASTERS



AK-001
SINGLE DISPLAYER
WITH CASTERS
PACK: 1 / WT: 24

DOUBLE DISPLAYER WITH CASTERS



AK-002
DOUBLE DISPLAYER
WITH CASTERS
PACK: 1 / WT: 38

TRIPLE DISPLAYER WITH CASTERS



AK-003
TRIPLE DISPLAYER
WITH CASTERS
PACK: 1 / WT: 53

SATIN NICKEL HARDWARE



AK-GR3
3" HANGRAIL BRACKET
PACK: 25 / WT: 23



AK-12
12" FACEOUT
PACK: 25 / WT: 23



AK-GR12
12" HANGRAIL BRACKET
PACK: 25 / WT: 23



AK-ML
MILLINERY DISPLAYER
PACK: 25 / WT: 17



AK-7B
7-BALL WATERFALL
PACK: 25 / WT: 35

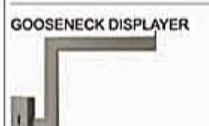

AK-GD
12" HANGRAIL BRACKET
PACK: 25 / WT: 49



AK-4CH
24"W X 4"D
U-HANGRAIL
PACK: 10 / WT: 24

AK-12CH
24"W X 12"D
U-HANGRAIL
PACK: 10 / WT: 30



AK-RH12
12" RECT. FACEOUT FOR HANGRAIL
PACK: 25 / WT: 25



AK-EC4
END CAP
PACK: 100
WT: 9



AK-HR SHELF
24"W X 12"D
U-HANGRAIL
WITH WOOD SHELF
PACK: 4 / WT: 38



AK-H4
4" HANGRAIL HOOK
PACK: 100 / WT: 16

AK-H6
6" HANGRAIL HOOK
PACK: 100 / WT: 18

AK-H9
9" HANGRAIL HOOK
PACK: 100 / WT: 26

AK-H12
12" HANGRAIL HOOK
PACK: 100 / WT: 28



AK-RE2
24" HANGRAIL - 1/2" X 1-1/2" RECT.
PACK: 10 / WT: 15

AK-RE4
48" HANGRAIL - 1/2" X 1-1/2" RECT.
PACK: 10 / WT: 30

**SATIN NICKEL FINISH
LADDER SYSTEM - HL**

SINGLE DISPLAYER WITH CASTERS



HL-001
SINGLE DISPLAYER WITH CASTERS
62"H
PACK: 1
WT: 33

DOUBLE DISPLAYER WITH CASTERS



HL-002
DOUBLE DISPLAYER WITH CASTERS
62"(H) X 24"(W)
PACK: 1
WT: 44

TRIPLE DISPLAYER WITH CASTERS



HL-003
TRIPLE DISPLAYER WITH CASTERS
62"(H) X 51"(W)
PACK: 1
WT: 67



HL-GR3
3" RECTANGULAR HANGRAIL BRACKET
PACK: 25 / WT: 10

HL-GR8
8" RECTANGULAR HANGRAIL BRACKET
PACK: 25 / WT: 16

HL-GR12
12" RECTANGULAR HANGRAIL BRACKET
PACK: 25 / WT: 21

WALL STANDARD

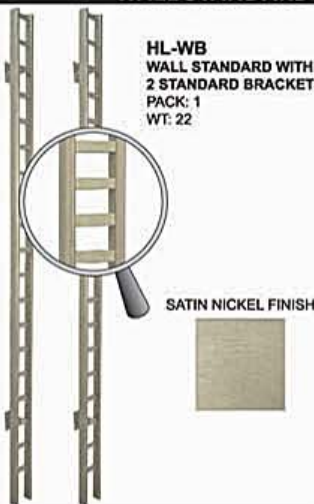

HL-WB
WALL STANDARD WITH
2 STANDARD BRACKETS
PACK: 1
WT: 22

SATIN NICKEL FINISH



HL-ML
MILLINERY DISPLAYER
PACK: 25
WT: 13



HL-GR3
3" RECTANGULAR HANGRAIL BRACKET
PACK: 25 / WT: 10

HL-GR8
8" RECTANGULAR HANGRAIL BRACKET
PACK: 25 / WT: 16

HL-GR12
12" RECTANGULAR HANGRAIL BRACKET
PACK: 25 / WT: 21

SATIN NICKEL HARDWARE



HL-HR SHF
12" HANGRAIL WITH METAL SHELF
PACK: 4
WT: 29



HL-H4 4" HANGRAIL HOOK
PACK: 100 / WT: 14
HL-H6 6" HANGRAIL HOOK
PACK: 100 / WT: 17
HL-H9 9" HANGRAIL HOOK
PACK: 100 / WT: 20
HL-H12 12" HANGRAIL HOOK
PACK: 100 / WT: 25



HL-12
12" FACEOUT
PACK: 25 / WT: 25



HL-7B
7-BALL WATERFALL
PACK: 25 / WT: 34



HL-GD
12" HANGRAIL BRACKET
PACK: 25
WT: 31

GOOSENECK DISPLAYER



HL-4CH
24"W X 4"D
U-HANGRAIL
PACK: 10 / WT: 18





HL-12CH
24"W X 12"D
U-HANGRAIL
PACK: 4 / WT: 22









HL-RE2
24" RECT. HANGRAIL
WITH WELDED END CAP
PACK: 10 / WT: 15

HL-RE4
48" RECT. HANGRAIL
WITH WELDED END CAP
PACK: 10 / WT: 25

FULLY ASSEMBLED LED LIGHTED TOWER SHOWCASES

Item & Description	Color	Pack	Wt
 <p>KDWA-001 SQUARE LIGHTED TOWER SHIPS FULLY ASSEMBLED DIMENSIONS : 20"(L) x 20"(W) x 73"(H) CANOPY: 4 1/2"(H) STORAGE: 14"(H)</p> <p>SHOWCASE INCLUDES: 3PCS TEMPERED GLASS ADJUSTABLE SHELVES 8 LED LIGHTS (TOP: 4 SIDE: 4 ADJUSTABLE)- 24W BOTTOM CABINET WITH LOCKING DOORS & KEYS ELECTRICAL CORD AND SWITCH</p>	BLACK	1	209
 <p>KDWA-002 RECTANGULAR LIGHTED TOWER SHIPS FULLY ASSEMBLED DIMENSIONS : 40"(L) x 18"(W) x 73"(H) CANOPY: 4. 1/2"(H) STORAGE: 14"(H)</p> <p>SHOWCASE INCLUDES: 4PCS TEMPERED GLASS ADJUSTABLE SHELVES 12 LED LIGHTS (TOP: 4 SIDE: 8 ADJUSTABLE)- 36W BOTTOM CABINET WITH LOCKING DOORS & KEYS ELECTRICAL CORD AND SWITCH</p>	BLACK	1	264
 <p>KDWA-003 HEXAGON LIGHTED TOWER SHIPS FULLY ASSEMBLED DIMENSIONS : 25"(L) x 22"(W) x 73"(H) STORAGE: 14"(H) CANOPY: 4. 1/2"(H)</p> <p>SHOWCASE INCLUDES: 4PCS TEMPERED GLASS ADJUSTABLE SHELVES 12 LED LIGHTS (TOP: 4 SIDE: 8 ADJUSTABLE)- 36W BOTTOM CABINET WITH LOCKING DOORS & KEYS ELECTRICAL CORD AND SWITCH</p>	BLACK	1	242
 <p>KDWA-004 ELONGATED HEXAGON LIGHTED TOWER SHOWCASE SHIPS FULLY ASSEMBLED DIMENSIONS : 33"(L) x 22"(W) x 73"(H) CANOPY: 4. 1/2"(H) STORAGE: 14"(H)</p> <p>SHOWCASE INCLUDES: 4PCS TEMPERED GLASS ADJUSTABLE SHELVES 12 LED LIGHTS (TOP: 4 SIDE: 8 ADJUSTABLE)- 36W BOTTOM CABINET WITH LOCKING DOORS & KEYS ELECTRICAL CORD AND SWITCH</p>	BLACK	1	286

FULLY ASSEMBLED LED LIGHTED TOWER SHOWCASES

Item & Description	Color	Pack	Wt
 <p>KDSNR03/BK KDSNR03/WH</p> <p>COUNTERTOP SHOWCASE SHIPS FULLY ASSEMBLED DIMENSIONS : 14 1/3"(L) x 14 1/3"(W) x 34"(H)</p> <p>SHOWCASE INCLUDES: 2 TEMPERED 1/4" T GLASS SHELVES 4 LED SPOT LIGHTS - 12W MDF TOP AND BOTTOM ELECTRICAL CORD AND SWITCH</p> 	BLACK WHITE	1 1	100 100
 <p>KDLC500/BK KDLC500/WH</p> <p>SINGLE TOWER SHOWCASE SHIPS FULLY ASSEMBLED DIMENSIONS : 19 1/2"(L) x 19 1/2"(W) x 78"(H)</p> <p>SHOWCASE INCLUDES: 4 ADJUSTABLE 1/4" T TEMPERED GLASS SHELVES 8 LED SPOT LIGHTS (TOP: 4 & SIDE: 4) - 24W LOCKING HINGED GLASS DOOR ALUMINUM FRAME ELECTRICAL CORD AND SWITCH</p> 	BLACK WHITE	1 1	147 147
 <p>KDLC1000/BK KDLC1000/WH</p> <p>DOUBLE TOWER SHOWCASE SHIPS FULLY ASSEMBLED DIMENSIONS : 39 1/3"(L) x 15 3/4"(W) x 78"(H)</p> <p>SHOWCASE INCLUDES: 4 ADJUSTABLE 1/4" T TEMPERED GLASS SHELVES 8 LED SPOT LIGHTS (TOP: 2 & SIDE: 6) - 24W LOCKING HINGED GLASS DOOR ALUMINUM FRAME ELECTRICAL CORD AND SWITCH</p> 	BLACK WHITE	1 1	284 284

SHOWCASE- FRAMELESS GLASS

SHOWCASES

Item & Description Color Pack Wt



FCC24
 FRAMELESS - 13"(W) x 13"(D) x 24"(H)
 SHELVES ARE NOT ADJUSTABLE
 1/4" TEMPERED GLASS
 LOCK INCLUDED
 BASE HEIGHT - 1"

GLASS 1 33



FFV36
 FRAMELESS - 36"(W) x 20"(D) x 38"(H)
 2 ADJUSTABLE SHELVES 34"(L) x 18"(W)
 1/4" TEMPERED GLASS
 PLUNGER INCLUDED
 BASE HEIGHT - 6"

GLASS 1 140



FTC20
 FRAMELESS - 20"(W) x 20"(D) x 72"(H)
 4 ADJUSTABLE SHELVES 18"(L) X 18"(W)
 1/4" TEMPERED GLASS
 PLUNGER INCLUDED
 BASE HEIGHT - 6"

GLASS 1 154



FTC36
 FRAMELESS - 36"(W) x 16"(D) x 72"(H)
 4 ADJUSTABLE SHELVES 34"(L) X 14"(W)
 1/4" TEMPERED GLASS
 PLUNGER INCLUDED
 BASE HEIGHT - 7"

GLASS 1 215



FTC48
 FRAMELESS - 48"(L) x 18"(W) x 72"(H)
 4 ADJUSTABLE SHELVES 46"(L) x 16"(W)
 1/4" TEMPERED GLASS
 PLUNGER INCLUDED
 BASE HEIGHT - 7"

GLASS 1 375



SHOWCASE- EXTRA VISION

Item & Description Color Pack Wt



ESC4
 4' EXTRA VISION SHOWCASE-48"(W) x 20"(D) x 38"(H)
ESC6
 6' EXTRA VISION SHOWCASE-72"(W) x 20"(D) x 38"(H)
K/D EXTRA VISION SHOWCASE INCLUDES :
 2 ROWS OF ADJUSTABLE GLASS SHELVES
 TOP GLASS: 68 13/16"(L) x 18 13/16"(W)
 GLASS SHELVES: TOP SHELF 8"D & BOTTOM SHELF 10"D
 34"(H) GLASS DISPLAY AREA
 4" BLACK KICK BASE
 PLUNGER LOCK INCLUDED

ALUMINIUM 1 195
 ALUMINIUM 1 255



ESC4/B
 4' EXTRA VISION SHOWCASE-48"(W) x 20"(D) x 38"(H)
ESC6/B
 6' EXTRA VISION SHOWCASE-72"(W) x 20"(D) x 38"(H)



BLACK 1 195
 BLACK 1 255



EX-BCC
 CORNER PENTAGON FILLER
 60"(W) x 20"(D) x 38"(H)
 32"(H) GLASS DISPLAY AREA
 1: 8"(D) ADJUSTABLE SHELF
 1: 10"(D) ADJUSTABLE SHELF
 4" BLACK KICK BASE
 1/4"(T) SLIDING REAR ACCESS DOOR
 PLUNGER LOCK INCLUDED

ALUMINIUM 1 195



EX-BCC/B



BLACK 1 195



EPC
 CORNER TRIANGULAR FILLER
 20"(L) x 20"(D) x 20" x 38"(H)
 32"(H) GLASS DISPLAY AREA
 2: 1/4"(T) ADJUSTABLE GLASS SHELVES
 4" BLACK KICK BASE
 PLUNGER LOCK INCLUDED

ALUMINIUM 1 45

EPC/B



BLACK 1 45

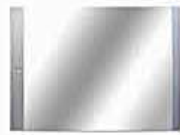

EMD-4
 MIRROR DOOR FOR 4' EXTRA VISION

1 16



EMD-6
 MIRROR DOOR FOR 6' EXTRA VISION

1 20



SC-PL
 PLUNGER LOCK

1 1



SC-RL
 RACHET LOCK
 INCLUDES 2 KEYS

1 1



LEDLIGHT4 : 4' SHOWCASE LED LIGHTS
LEDLIGHT5 : 5' SHOWCASE LED LIGHTS
LEDLIGHT6 : 6' SHOWCASE LED LIGHTS

1 6
 1 7
 1 8

SHOWCASES

SHOWCASE - FULL VISION



4" SHOWCASE DIMENSION - 48" x 18" x 38"
 5" SHOWCASE DIMENSION - 60" x 18" x 38"
 6" SHOWCASE DIMENSION - 72" x 18" x 38"

SHOWCASES INCLUDE :
 2 ADJUSTABLE GLASS SHELVES (10" & 12")
 BASE IS 10"H, FRONT VIEWING AREA IS 28"
 INCLUDES LOCK INSTALLED

Item	Description	Color	Pack	Wt
SC4M	4" FULL VISION SHOWCASE	MAPLE	1	130
SC5M	5" FULL VISION SHOWCASE	MAPLE	1	158
SC6M	6" FULL VISION SHOWCASE	MAPLE	1	180
SC4B	4" FULL VISION SHOWCASE	BLACK	1	130
SC5B	5" FULL VISION SHOWCASE	BLACK	1	158
SC6B	6" FULL VISION SHOWCASE	BLACK	1	180
SC4W	4" FULL VISION SHOWCASE	WHITE	1	130
SC5W	5" FULL VISION SHOWCASE	WHITE	1	158
SC6W	6" FULL VISION SHOWCASE	WHITE	1	180
SC4C	4" FULL VISION SHOWCASE	CHERRY	1	130
SC5C	5" FULL VISION SHOWCASE	CHERRY	1	158
SC6C	6" FULL VISION SHOWCASE	CHERRY	1	180
FMD - 4	MIRROR DOOR FOR FULL VISION 4" SHOWCASE	MIRROR	1	16
FMD - 6	MIRROR DOOR FOR FULL VISION 6" SHOWCASE	MIRROR	1	20

SHOWCASE - HALF VISION



SHOWCASES INCLUDE :
 1 ADJUSTABLE GLASS SHELF (12")
 GLASS DISPLAY AREA IS 18"H x 20"D
 REAR STORAGE ON BOTTOM IS 10"H
 BASE IS 20", FRONT VIEWING AREA IS 18"
 INCLUDES LOCK INSTALLED

4" SHOWCASE DIMENSION - 48" x 18" x 38"
 6" SHOWCASE DIMENSION - 72" x 18" x 38"

Item	Description	Color	Pack	Wt
SCH4M	4" HALF VISION SHOWCASE	MAPLE	1	133
SCH6M	6" HALF VISION SHOWCASE	MAPLE	1	216
SCH4B	4" HALF VISION SHOWCASE	BLACK	1	133
SCH6B	6" HALF VISION SHOWCASE	BLACK	1	216
SCH4W	4" HALF VISION SHOWCASE	WHITE	1	133
SCH6W	6" HALF VISION SHOWCASE	WHITE	1	216

CASH REGISTER STANDS & CORNERS



CW21-4B
 CW21-4W
 CW21-4M
 CW21-4C

2 FOR 1 CASH WRAP REGISTER COUNTER
 48"L x 18"W x 38"H
 SHELF: 23"L x 17"W
 HEIGHT ADJUSTABLE
 DRAWER W/LOCK & KEYS
 RECESSED WELL TO HIDE CORDS

BLACK
 WHITE
 MAPLE
 CHERRY

1 120
 1 120
 1 120
 1 120



SCRCB
 SCRCW
 SCRCM
 SCRC C

CASH REGISTER STAND INCLUDES:
 1 ADJUSTABLE STORAGE SHELF
 4" HIGH DRAWER
 24"(L) x 18"(W) x 38"(H)
 DRAWER W/LOCK & KEYS

BLACK
 WHITE
 MAPLE
 CHERRY

1 81
 1 81
 1 81
 1 81



SCRGB
 SCRGW
 SCRCM
 SCRC C

CASH REGISTER STAND WITH GLASS INCLUDES:
 1 ADJUSTABLE TEMPERED GLASS SHELF
 24"(L) x 18"(W) x 38"(H)

BLACK
 WHITE
 MAPLE
 CHERRY

1 68
 1 68
 1 68
 1 68



SCTCB
 SCTCW
 SCTCM
 SCTCC

TRIANGLE CORNER WITH GLASS SHELF INCLUDES:
 2 ADJUSTABLE TEMPERED GLASS SHELVES
 18"(L) x 18"(W) x 38"(H)

BLACK
 WHITE
 MAPLE
 CHERRY

1 36
 1 36
 1 36
 1 36



SCPC18B
 SCPC18W
 SCPC18M
 SCPC18C

PENTAGONAL CORNER WITH GLASS SHELF INCLUDES:
 2 ADJUSTABLE TEMPERED GLASS SHELVES
 18"(L) x 18"(W) x 38"(H)

BLACK
 WHITE
 MAPLE
 CHERRY

1 38
 1 38
 1 38
 1 38

Item	Description	Color	Pack	Wt
------	-------------	-------	------	----

SHOWCASE- WALL CASE DISPLAYS



WC4-M

WC4-B

WC4-W

WALL DISPLAYS
FEATURES:
 48"(L) x 18"(W) x 78"(H)
 5-ADJUSTABLE GLASS SHELVES (12")
 3-HOLOGEN LIGHTS
 GLASS SHELVES: 1/4"(T) & 12"(D)
 1/4" SLIDING DOORS
 INCLUDES PLUNGER LOCK

WC4-M	MAPLE	1	304
WC4-B	BLACK	1	304
WC4-W	WHITE	1	304

LEDGETOP COUNTERS

LGT-4M
LGT-4B
LGT-6M
LGT-6B

48"(W) x 22"(D) x 42"(H)
 48"(W) x 22"(D) x 42"(H)
 72"(W) x 22"(D) x 42"(H)
 72"(W) x 22"(D) x 42"(H)

TOP REGISTER STAND
FEATURES:
 PULL OUT DRAWER W/LOCK & KEYS :6"(H)
 CHECK WRITING SHELF: 8 3/4"
 2 ADJUSTABLE SHELVES
 3/4" MAPLE MELAMINE
 RECESSED WELL TO HIDE CORDS

MAPLE	1	160
BLACK	1	160
MAPLE	1	215
BLACK	1	215

SW-LGT-4B
SW-LGT-4M
SW-LGT-6B
SW-LGT-6M

48"(W) x 22"(D) x 42"(H)
 48"(W) x 22"(D) x 42"(H)
 72"(W) x 22"(D) x 42"(H)
 72"(W) x 22"(D) x 42"(H)

SLATWALL FRONT TOP REGISTER STAND
FEATURES:
 SLATWALL FEATURE ON THE FRONT
 PULL OUT DRAWER W/LOCK & KEYS :6"(H)
 CHECK WRITING SHELF: 8 3/4"
 2 SHELVES ARE ADJUSTABLE
 3/4" MAPLE MELAMINE
 RECESSED WELL TO HIDE CORDS

BLACK	1	160
MAPLE	1	160
BLACK	1	215
MAPLE	1	215

CW4(M)
CW4(W)
CW4(B)
CW6(M)
CW6(W)
CW6(B)

48"(W) x 18"(D) x 38"(H)
 48"(W) x 18"(D) x 38"(H)
 48"(W) x 18"(D) x 38"(H)
 72"(W) x 18"(D) x 38"(H)
 72"(W) x 18"(D) x 38"(H)
 72"(W) x 18"(D) x 38"(H)

WRAP COUNTERS
FEATURES:
 2 SHELVES ARE ADJUSTABLE
 LARGE FLAT TOP SURFACE

MAPLE	1	139
WHITE	1	139
BLACK	1	139
MAPLE	1	190
WHITE	1	190
BLACK	1	190

Item & Description	Color	Pack	Wt
--------------------	-------	------	----

COUNTERTOP- GLASS SHOWCASES



F-1301
F-1301(B)
GLASS SHOWCASE W/SHELVES
LOCK & KEYS INCLUDED
 24"(L) x 12"(W) x 18"(H)

SILVER
BLACK1
1
19
19

F-1302
F-1302(B)
GLASS SHOWCASE W/SHELVES
LOCK & KEYS INCLUDED
 14"(L) x 12"(W) x 27"(H)

SILVER
BLACK1
1
17
17

F-1303
F-1303(B)
GLASS SHOWCASE
LOCK & KEYS INCLUDED
 30"(L) x 18"(W) x 9"(H)

SILVER
BLACK1
1
18
18

COUNTERTOP- ACRYLIC SHOWCASES



ACTJ3
 Locking 3 Shelf Showcase
 13"L x 7 1/2"W x 21"H
 PACK: 1 WT: 18 LBS.



ACTJ2
 Locking 2 Shelf Showcase
 21"L x 7 1/2"W x 13"H
 PACK: 1 WT: 14 LBS.



ACLC
 Locking Showcase
 24"L x 18"W x 3"H
 PACK: 1 WT: 8 LBS.

Satin Chrome & Maple S.W
SLATWALL MERCHANDISER

2- SIDED SLATWALL MERCHANDISER



SM1
1EA PANEL - 25"(L) x 25"(W) x 54"(H)
SATIN NICKEL FRAME STANDARD W/ ALUMINUM INSERTS
INCLUDES 2 LOCKING & 2 W/O LOCKING 3" H.D CASTERS
PACK: 1 / WT: 84

PINWHEEL MERCHANDISER



SM2
4 PANELS - 25"(L) x 25"(W) x 54"(H)
SATIN NICKEL FRAME STANDARD W/ ALUMINUM INSERTS
INCLUDES 2 LOCKING & 2 W/O LOCKING 3" H.D CASTERS
PACK: 1 / WT: 154

T-SIDED SLATWALL MERCHANDISER



SM3
2 PANELS - 25"(L) x 25"(W) x 54"(H)
SATIN NICKEL FRAME STANDARD W/ ALUMINUM INSERTS
INCLUDES 2 LOCKING & 2 W/O LOCKING 3" H.D CASTERS
PACK: 1 / WT: 108

H-RACK MERCHANDISER



SM4
3 PANELS - 25"(L) x 25"(W) x 54"(H)
SATIN NICKEL FRAME STANDARD W/ ALUMINUM INSERTS
INCLUDES 2 LOCKING & 2 W/O LOCKING 3" H.D CASTERS
PACK: 1 / WT: 150

GONDOLA SLATWALL MERCHANDISER



SM5
3 PANELS - 50"(L) x 25"(W) x 54"(H)
SATIN NICKEL FRAME STANDARD
W/ ALUMINUM INSERTS
INCLUDES 2 LOCKING
& 2 W/O LOCKING 3" H.D CASTERS
PACK: 1 / WT: 213

SLATWALL MERCHANDISER ACCESSORIES



SM-811
ATTACHABLE CLEAR SIGN HOLDER
FOR SM1, SM3, SM4, SM5
11"(W) X 8"(H)
PACK: 1 / WT: 2



AK-4CH
24"W X 4"D
U-HANGRAIL
PACK: 10 / WT: 24

AK-12CH
24"W X 12"D
U-HANGRAIL
PACK: 10 / WT: 30



AK-HR SHELF
24"(W) x 12"(D) HANGRAIL
WITH WOOD SHELF
PACK: 4 / WT: 38



AK-GR12
12" HANGRAIL BRACKET
PACK: 25 / WT: 23



BSK2412/CH
CHROME / PACK: 6 / WT: 27
BSK2412/BLK
BLACK / PACK: 6 / WT: 27
BSK2412/WTE
WHITE / PACK: 6 / WT: 27

24"X12" WIRE SHELF

EURO LOOP HOOKS



SW/UH4 4" HOOK PACK: 100 / WT: 26
SW/UH6 6" HOOK PACK: 100 / WT: 30
SW/UH8 8" HOOK PACK: 100 / WT: 33
SW/UH10 10" HOOK PACK: 100 / WT: 37
SW/UH12 12" HOOK PACK: 100 / WT: 42

ZINC - 3/16" WIRE

SCANNER HOOKS W/PRICE TAG HOLDER



SW/SNH4 4" HOOK PACK: 100 / WT: 16
SW/SNH6 6" HOOK PACK: 100 / WT: 22
SW/SNH8 8" HOOK PACK: 100 / WT: 26
SW/SNH10 10" HOOK PACK: 100 / WT: 27
SW/SNH12 12" HOOK PACK: 100 / WT: 29

ZINC - 3/16" WIRE



AK-RE2
24" HANGRAIL - 1/2" X 1-1/2" RECT.
PACK: 10 / WT: 15

AK-RE4
48" HANGRAIL - 1/2" X 1-1/2" RECT.
PACK: 10 / WT: 28

DISPLAYERS- BIN&TRAY



SWPTH
TRIPLE HOISERY BIN- ACRYLIC
24"(L) x 7 1/2"(W) x 4 1/4"(H) x 1/8"(T)
CLEAR / PACK: 6 / WT: 21



AK-H4 4" HANGRAIL HOOK
PACK: 100 / WT: 15

AK-H6 6" HANGRAIL HOOK
PACK: 100 / WT: 18

AK-H9 9" HANGRAIL HOOK
PACK: 100 / WT: 26

HEAVY DUTY SHELVES



ASW1218
GLASS SHELVES
18"(W) x 12"(D) x 3/16"(T)
CLEAR / PACK: 2 / WT: 4

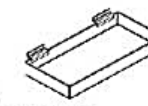

SWP2222
DISPLAY TRAY - ACRYLIC
16"(L) x 8"(W) x 2"(H) x 3/16"(T)
CLEAR / PACK: 10 / WT: 16



ASW1224
GLASS SHELVES W/ REINFORCEMENT BAR
24"(W) x 12"(D) x 3/16"(T)
CLEAR / PACK: 2 / WT: 4

SEE ADDITIONAL ACCESSORIES ON PG. 77 ~ 83

SLATWALL MERCHANDISERS

Item & Description Color Pack Wt



SLATWALL 4-WAY OR "PINWHEEL" DISPLAY
36"(L) x 36"(D) x 54"(H) x 6"(B)

SM-4W(M)	MAPLE	1	111
SM-4W(B)	BLACK	1	111
SM-4W(W)	WHITE	1	111



SLATWALL TOWER
24"(L) x 24"(D) x 54"(H) x 6"(B)

SM-CD(M)	MAPLE	1	75
SM-CD(B)	BLACK	1	75
SM-CD(W)	WHITE	1	75



SLATWALL ROTATING TOWER
12"(L) x 12"(D) x 54"(H) x 6"(B)

SW-1212(M)	MAPLE	1	55
SW-1212(B)	BLACK	1	55
SW-1212(W)	WHITE	1	55



SLATWALL ROTATING TOWER
20"(L) x 20"(D) x 60"(H) x 6"(B)

SW-2020(M)	MAPLE	1	111
SW-2020(B)	BLACK	1	111
SW-2020(W)	WHITE	1	111



SLATWALL "T" MERCHANDISER DISPLAY
24"(L) x 25 1/2"(D) x 54"(H) x 6"(B)

SM-SD(M)	MAPLE	1	75
SM-SD(B)	BLACK	1	75
SM-SD(W)	WHITE	1	75



SLATWALL H-UNIT
49-1/2"(L) x 24"(D) x 54"(H) x 6"(B)

SM-BH(M)	MAPLE	1	180
SM-BH(B)	BLACK	1	180
SM-BH(W)	WHITE	1	180

Color Pack Wt

SLATWALL MERCHANDISERS



"L" SHAPE MERCHANDISER
ONE SIDED SLATWALL DISPLAY

SM-LS(M)
48"(L) x 20"(D) x 80"(H) x 6"(B)
PACK : 1 WEIGHT : 110

SM-LS(B)
48"(L) x 20"(D) x 80"(H) x 6"(B)
PACK : 1 WEIGHT : 110

SM-LS(W)
48"(L) x 20"(D) x 80"(H) x 11 1/4"(B)
PACK : 1 WEIGHT : 110

SLATWALL MERCHANDISERS - COUNTERTOP



WD2CT

ROTATING COUNTERTOP DISPLAY
18"(W) x 12"(D) x 21 1/2"(H)

MAPLE

1 15



WD4R-CT

4-WAY COUNTERTOP SPINNER
12"(W) x 12"(D) x 21 1/2"(H)

MAPLE

1 15



WD4S-CT

4-SIDED COUNTERTOP SPINNER
12"(W) x 12"(D) x 25"(H)

MAPLE

1 28

Item Description Color Pack Wt

SLATWALL HOOKS- NOTCH, REGULAR & THIN







	SP/NHK SPB/NHK SPW/NHK	NOTCH HOOK	CHROME BLACK WHITE	100 100 100	10 10 10
	SP/H1 SPB/H1 SPW/H1	1" HOOK	CHROME BLACK WHITE	100 100 100	12 12 12
	SP/H2 SPB/H2 SPW/H2	2" HOOK	CHROME BLACK WHITE	100 100 100	14 14 14
	SP/H4 SPB/H4 SPW/H4	4" HOOK	CHROME BLACK WHITE	100 100 100	14 14 14
	SP/H6 SP/H6-SC SPB/H6 SPW/H6	6" HOOK	CHROME SATIN CHROME BLACK WHITE	100 100 100 100	17 17 17 17
	SP/H8 SP/H8-SC SPB/H8 SPW/H8	8" HOOK	CHROME SATIN CHROME BLACK WHITE	100 100 100 100	20 20 20 20
	SP/H10 SP/H10-SC SPB/H10 SPW/H10	10" HOOK	CHROME SATIN CHROME BLACK WHITE	100 100 100 100	23 23 23 23
	SP/H12 SPB/H12 SPW/H12	12" HOOK	CHROME BLACK WHITE	100 100 100	28 28 28
	XTW/H1-CH XTW/H4-CH XTW/H6-CH XTW/H8-CH XTW/H10-CH XTW/H12-CH	1" THIN HOOK 4" THIN HOOK 6" THIN HOOK 8" THIN HOOK 10" THIN HOOK 12" THIN HOOK	CHROME CHROME CHROME CHROME CHROME CHROME	100 100 100 100 100 100	13 13 15 17 19 21
	WHK/R	ANTI-THEFT MAGNETIC SECURITY DISPLAY HOOK LOOK FITS 1/4" THICK HOOKS FOR PEGBOARD & SLATWALL HOOKS	RED	100	2
	WMD	MAGNETIC DETACHER KEY	SILVER	1	1

SPECIAL SLATWALL HOOKS & PEG HOOKS

	SW/UH4 SW/UH6 SW/UH8 SW/UH10 SW/UH12	EURO LOOP HOOKS- 3/16" WIRE	ZINC ZINC ZINC ZINC ZINC	100 100 100 100 100	28 30 33 37 42
	SW/SNH4 SW/SNH6 SW/SNH8 SW/SNH10 SW/SNH12	SCANNER HOOKS W/PRICE TAG HOLDER- 3/16" WIRE	ZINC ZINC ZINC ZINC ZINC	100 100 100 100 100	16 22 26 27 29
	PEG/BH4 PEG/BH6 PEG/BH8 PEG/BH10 PEG/BH12	PEG HOOKS W/BALL TIP END- 3/16" WIRE	ZINC ZINC ZINC ZINC ZINC	100 100 100 100 100	4 6 7 10 13

Item Description Color Pack Wt









SLATWALL BRACKETS

	SP/8KB SPB/8KB SPW/8KB	8" KNIFE BRACKET	CHROME BLACK WHITE	50 50 50	21 21 21
	SP/10KB SPB/10KB SPW/10KB	10" KNIFE BRACKET	CHROME BLACK WHITE	50 50 50	23 23 23
	SP/12KB SPB/12KB SPW/12KB	12" KNIFE BRACKET	CHROME BLACK WHITE	50 50 50	26 26 26
	SP/14KB SPB/14KB SPW/14KB	14" KNIFE BRACKET	CHROME BLACK WHITE	50 50 50	29 29 29
	SP/16KB SPB/16KB SPW/16KB	16" KNIFE BRACKET	CHROME BLACK WHITE	50 50 50	35 35 35
	SP/ADJ12 SP/ADJ14	12" ADJUSTABLE SHELF BRACKET 14" ADJUSTABLE SHELF BRACKET	CHROME CHROME	50 50	33 36



SLATWALL FACEOUTS & WATERFALLS

	SP/12 SPB/12 SPW/12	12" FACEOUT - SQUARE TUBING	CHROME BLACK WHITE	25 25 25	20 20 20
	RW/12-CH RW/12-WTE	12" FACEOUT - RECTANGULAR TUBING	CHROME WHITE	25 25	24 24
	RW/3-CH RW/6-CH	3" FACEOUT - RECTANGULAR TUBING 3" FACEOUT W/ DISC AT END	CHROME CHROME	25 25	9 11
	SP/6B SPB/6B SPW/6B	6-BALL WATERFALL - SQUARE TUBING	CHROME BLACK WHITE	25 25 25	28 28 28
	SP/5H SPB/5H SPW/5H	5-HOOK WATERFALL - SQUARE TUBING	CHROME BLACK WHITE	25 25 25	29 29 29
	RW/5H-CH	5-HOOK WATERFALL - RECTANGULAR TUBING	CHROME	25	33
	RW7B-CH	7-CUBE WATERFALL - RECTANGULAR TUBING	CHROME	25	30
	SP/FRC	3" FACEOUT W/ DISC AT END	CHROME	25	8

SLATWALL HANGRAILS & BRACKETS

Item	Description	Color	Pack	Wt
	SP/SB SLATWALL STEP BRACKET 22"L x 8"H UPRIGHT	CHROME	25	55
	SP/681 SPB/681 SPW/681 U-SHAPE ROUND TUBING HANGRAIL 21"L x 10 1/2"D 1 1/2" TUBING	CHROME BLACK WHITE	10 10 10	31 31 31
	SP/R81 U-SHAPED RECTANGULAR TUBING HANGRAIL 21"L x 10 1/2"D 1 1/2" TUBING	CHROME	10	31
	SP/FB 12" RECT. HANGRAIL BRACKET FOR RECT. TUBUNG	CHROME	25	32
	SP/R2 2" RECT. HANGRAIL BRACKET FOR RECT. TUBING	CHROME	25	17
	SP/RM 12" HANGRAIL B/K FOR 1" x 1-1/16" ROUND HANGRAIL	CHROME	25	30
	SP/RT 12" HANGRAIL B/K FOR 1-1/4" ROUND HANGRAIL	CHROME	25	30
	SP/ML SPB/ML SPW/ML MILLINERY DISPLAYER NO FOAM PAD 1 1/4"L x 5 1/8"H x 2 3/4"D	CHROME BLACK WHITE	25 25 25	15 15 15

SLATWALL DISPLAYERS- WIRE SHELF & CAP

	SP/CAP-S SPB/CAP-S SPW/CAP-S WIRE CAP DISPLAYER HOLDS 12 CAPS	CHROME BLACK WHITE	20 20 20	15 15 15
	SW/CAP5 CAP HOLDER FOR SLATWALL HOLDS 60 CAPS 44"(W) x 12"(D)	BLACK	1	8









SLATWALL DISPLAYERS- SHOE SHELF

Item	Description	Color	Pack	Wt
	SP/SSL SHOE SHELF- ACRYLIC 4" x 10" CLEAR SHOE SHELF WITH 1" CHANNEL FOR SIGNAGE	CLEAR	100	28
	SP/SS SHOE SHELF- ACRYLIC 4" x 10" CLEAR SHOE SHELF	CLEAR	100	25
	26-050CL SLATWALL SWIVEL SHOE DISPLAY 2 3/4"W x 9"L HEEL STOPPER	CLEAR	50	16
	26-055CL SLATWALL SHOE DISPLAY 2 3/4"W x 9"L TOE STOPPER	CLEAR	50	16



SLATWALL DISPLAYERS- SHELVES

	SWD/B24 SLATWALL MELAMINE WOOD TOP SHELF BLACK METAL U HANGRAIL 24"W x 12"D	BLACK WOOD/ BLACK METAL	2	17
	SWD/M24 SLATWALL MELAMINE WOOD TOP SHELF SATIN NICKEL METAL U HANGRAIL 24"W x 12"D	MAPLE WOOD/ S.N METAL	2	17
	ASW1218 ACRYLIC SHELVES 18"(W) x 12"(D) x 3/16"(T)	CLEAR	10	31
	ASW1224 ACRYLIC SHELVES W/ REINFORCEMENT BAR 24"(W) x 12"(D) x 3/16"(T)	CLEAR	10	37



SLATWALL DISPLAYERS- BROCHURE, MAGAZINE & SIGN HOLDERS

Item	Description	Color	Pack	Wt
  ALHS/49	BROCHURE & PAMPHLET SIGN HOLDER 4 1/2"L x 1"W x 8 1/2"H	CLEAR	24	5
  ALHS/811	MAGAZINE & CATALOG SIGN HOLDER 8 1/2"L x 2"W x 11"H	CLEAR	24	16
 	PORTRAIT SLATWALL SIGN HOLDERS SWP2031: 5 1/2"(W) x 7"(H) - 3/32" THICKNESS SWP2033: 7"(W) x 11"(H) - 3/32" THICKNESS SWP2035: 8 1/2"(W) x 11"(H) - 3/32" THICKNESS	CLEAR CLEAR CLEAR	48 25 25	19 20 20
 	LANDSCAPE SLATWALL SIGN HOLDERS SWP2032: 7"(W) x 5 1/2"(H) - 3/32" THICKNESS SWP2034: 11"(W) x 7"(H) - 3/32" THICKNESS SWP2036: 11"(W) x 8 1/2"(H) - 3/32" THICKNESS	CLEAR CLEAR CLEAR	48 25 25	19 20 20

SLATWALL DISPLAYERS- BOOK SHELF

	SWPJR36 J RACK FLAT BOTTOM- ACRYLIC 1/8"(T) x 36"(L)	CLEAR	12	16
	SWPJB24 J RACK FLAT BOTTOM FOR BOOK - ACRYLIC 3/16"(T) x 24"(L)	CLEAR	12	16
	SWPJB36 J RACK FLAT BOTTOM FOR BOOK - ACRYLIC	CLEAR	12	27

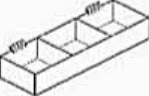
SLATWALL DISPLAYERS- BIN & TRAY

	SWPTH TRIPLE HOSEIERY BIN- ACRYLIC 24"(L) x 7 1/2"(W) x 4 1/4"(H) x 1/8"(T)	CLEAR	6	21
	SWP2222 DISPLAY TRAY- ACRYLIC 16"(L) x 8"(W) x 2"(H) x 3/16"(T)	CLEAR	6	9

SLATWALL DISPLAYERS & MOLDED BINS BASKETS

Item & Description	Color	Pack	Wt
 SPAB-75 ACRYLIC MOLDED BIN - 7 1/2" 6"(W) x 5 1/2"(H) x 7 1/2"(D) x 1/8"(T)	CLEAR	5	6
 SPAB-95 ACRYLIC MOLDED BIN - 9 1/2" 6"(W) x 5 1/2"(H) x 9 1/2"(D) x 1/8"(T)	CLEAR	5	6
 SPAB-115 ACRYLIC MOLDED BIN - 11 1/2" 6"(W) x 5 1/2"(H) x 11 1/2"(D) x 1/8"(T)	CLEAR	5	6
 SPAWB-12 ACRYLIC MOLDED DOUBLE WIDE BIN 12"(W) x 5 1/2"(H) x 9 1/2"(D) x 1/8"(T)	CLEAR	5	6
 SPAQ-12 ACRYLIC MOLDED BOWL 12"(L) x 6"(H) x 6"(D) x 1/8"(T)	CLEAR	5	6
 SPAB-12 ACRYLIC MOLDED ARC 12"(W) x 6"(H) x 6"(D) x 1/8"(T)	CLEAR	5	6
 SP-SBACK PEG BOARD ADAPTER 4 5/8"W x 1/3"H x 1 3/8"D NOTCHED BACK FITS 1" PEGBOARD 8 BINS FIT ACROSS A 4' SECTION	CLEAR	5	2
 SP-GBACK GRIDWALL ADAPTER 1 1/2"L x 1/2"W x 4 1/2"H	CLEAR	5	2

ALL-PURPOSE BASKETS- SLATWALL & GRIDWALL

Item	Description	Color	Pack	Wt
	BSK11/CH BSK11/BLK BSK11/WTE	SHALLOW BASKET 24"(W) X 12"(D) X 4"(H)	CHROME BLACK WHITE	6 16
				6 16
				6 16
	BSK12/CH BSK12/BLK BSK12/WTE	DOUBLE SLOPING BASKET 24"(W) X 10"(D) X 5"(H)	CHROME BLACK WHITE	6 18
				6 18
				6 18
	BSK13/CH BSK13/BLK BSK13/WTE	SMALL BASKET 12"(W) X 12"(D) X 4"(H)	CHROME BLACK WHITE	6 10
				6 10
				6 10
	BSK14/CH BSK14/BLK BSK14/WTE	SLOPED FRONT BASKET 12"(W) X 12"(D) X 8"(H)	CHROME BLACK WHITE	6 11
				6 11
				6 11
	BSK15/CH BSK15/BLK BSK15/WTE	DEEP BASKET 12"(W) X 12"(D) X 8"(H)	CHROME BLACK WHITE	6 14
				6 14
				6 14
	BSK16/CH BSK16/BLK BSK16/WTE	SLOPING BASKET 15"(W) X 12"(D) X 5"(H)	CHROME BLACK WHITE	6 10
				6 10
				6 10
	BSK17/CH BSK17/BLK BSK17/WTE	NARROW BASKET 12"(W) X 6"(D) X 6"(H)	CHROME BLACK WHITE	6 9
				6 9
				6 9
	BSK2412/CH BSK2412/BLK BSK2412/WTE	24" x 12" WIRE SHELF FOR SLATWALL & GRIDWALL	CHROME BLACK WHITE	6 27
				6 27
				6 27
	VS24-B VS24-W	VIDEO SHELF- 24"	BLACK WHITE	6 27
				6 27
	VS48-B VS48-W	VIDEO SHELF- 48"	BLACK WHITE	10 27
				10 27

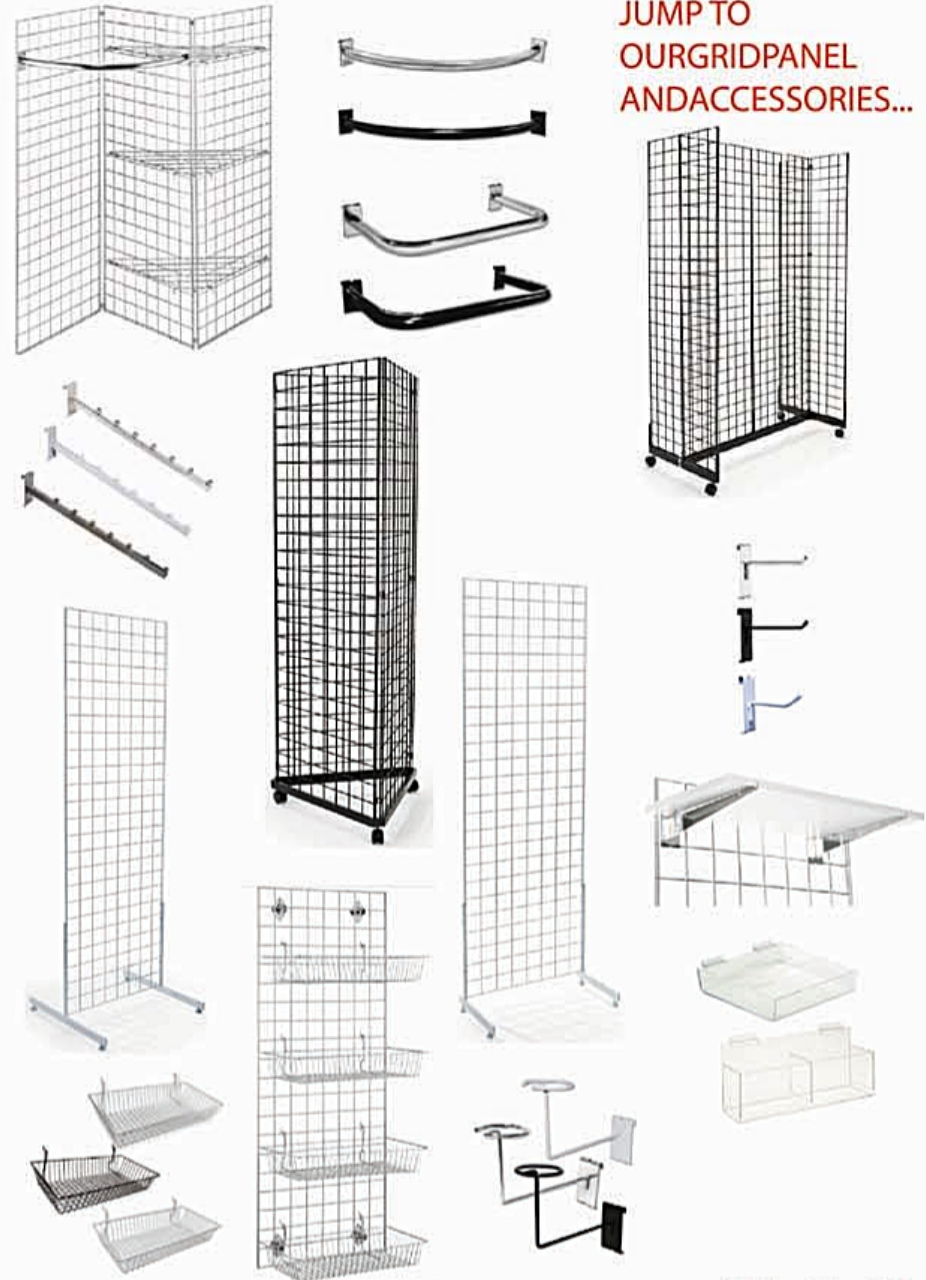

JUMP TO
OUR GRIDPANEL
AND ACCESSORIES...

Item & Description

Color

Pack Wt

COUNTERTOP DISPLAYS- JEWELRY



CSR-L
CSR-L/MAB
L-JEWELRY STAND
5" SQ. BASE
ADJUSTABLE UPRIGHT FROM 17" TO 31"

CHROME
MATTE BLACK

10 24
10 24



CSR-1
CSR-1/MAB
SINGLE JEWELRY STAND
7" SQ. BASE
ADJUSTABLE UPRIGHT FROM 14" TO 24"
ARM IS 13"L

CHROME
MATTE BLACK

10 35
10 35



CSR-2
CSR-2/MAB
2-TIER JEWELRY STAND
7" SQ. BASE
1ST TIER: ADJUSTABLE UPRIGHT FROM 15" TO 25"
2ND TIER: ADJUSTABLE UPRIGHT FROM 18" TO 29"
ARMS ARE 13"L

CHROME
MATTE BLACK

10 44
10 44



CSR-3
CSR-3/MAB
3-TIER JEWELRY STAND
7" SQ. BASE
1ST TIER: ADJUSTABLE UPRIGHT FROM 11" TO 18"
2ND TIER: ADJUSTABLE UPRIGHT FROM 15" TO 25"
3RD TIER: ADJUSTABLE UPRIGHT FROM 18" TO 29"
ARMS ARE 13"L

CHROME
MATTE BLACK

10 48
10 48

Item & Description

Color

Pack Wt

COUNTERTOP DISPLAYS- JEWELRY



CSR-SBS
SINGLE BRACELET STAND
13 1/2"(W) x 4"(D) x 8"(H)

CHROME

1 4



CSR-DBS
DOUBLE BRACELET STAND
13 1/4"(W) x 4"(D) x 11"(H)

CHROME

1 4



CSR-EF
2-WAY JEWELRY TOWER
INCLUDES 40 PIECES OF 3" HOOKS
15"(W) x 5 1/2"(D) x 18 1/2"(H)

CHROME

1 12



SJT-2
2-WAY SPINNING JEWELRY TOWER
BASE - 11 1/2" x 4 1/2"
15 1/2"(H) x 11 1/2"(W)
3" HOOKS SOLD SEPARATELY

CHROME

1 11



SJT-4
4-WAY SPINNING JEWELRY TOWER
BASE - 12" x 12"
18 1/2"(H) x 12"(D) x 12"(W)
3" HOOKS SOLD SEPARATELY

CHROME

1 18



3" HOOKS
3" HOOKS FOR JEWELRY TOWER

CHROME

50 5

MULTI-PURPOSE TIER DISPLAYS

Item & Description Color Pack Wt



CSR-CT1
VINTAGE COUNTERTOP DISPLAYS
12"D x 12"H
3 COMPARTMENTS- 6"L x 2 1/4"H
ROUND BASE: 8"D X 1/4"T

GUNMETAL

1 7



CSR-CT2
VINTAGE COUNTERTOP DISPLAYS (TWO-TIER)
15"D x 25"H
TOP TIER: 12"D x 2 1/4"H
BOTTOM TIER: 15"D x 2 1/4"H
10" APART BETWEEN TIERS
ROUND BASE: 8"D X 1/4"T

GUNMETAL

1 7



ITC1/2
VINTAGE MESH COUNTERTOP DISPLAYS (TWO-TIER)
13"L x 24"H
TOP TIER: 15"D x 2 1/2"
BOTTOM TIER: 20"D x 2 1/2"
INCLUDES A SIGN HOLDER SLOT
ANTIQUÉ IRON CAST 3 LEGGED BASE

RAW METAL

1 27



ITC1
RAW METAL MESH DISPLAYER ON IRON STAND- SMALL
13"L x 32 1/2"H
DISPLAY TOP: 15"D x 2 1/2"
POLE LENGTH IS 26"
ANTIQUÉ IRON CAST 3 LEGGED BASE

RAW METAL

1 19

ITC2
RAW METAL MESH DISPLAYER ON IRON STAND- SMALL
13"L x 40 1/2"H
DISPLAY TOP: 15"D x 2 1/2"
POLE LENGTH IS 34"
ANTIQUÉ IRON CAST 3 LEGGED BASE

RAW METAL

1 20

ITC/1

ITC/2

COUNTERTOP DISPLAYS - JEWELRY

Item Description Color Pack Wt



FA-004
8"(W) x 10"(H)
PACK: 2
WEIGHT: 4



FA-003
6 1/2"(W) x 10"(H)
PACK: 2
WEIGHT: 4



FA-036
11 1/2"(W) x 10 1/2"(H)
PACK: 2
WEIGHT: 4



FA-020
12 1/2"(W) x 13"(H)
PACK: 2
WEIGHT: 4



FA-066
9 1/2"(W) x 13 1/2"(H)
PACK: 2
WEIGHT: 4



FA-148
12"(W) x 11 1/2"(H)
PACK: 2
WEIGHT: 4



FA-030
12"(W) x 12"(H)
PACK: 2
WEIGHT: 4



FA-290
10"(W) x 10 1/2"(H)
PACK: 2
WEIGHT: 4



FA-058
12 1/2"(W) x 11 1/2"(H)
PACK: 2
WEIGHT: 4



FA-269
12 1/2"(W) x 11 1/2"(H)
PACK: 2
WEIGHT: 4

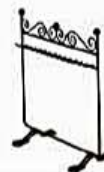

FA-270
8"(W) x 9 1/2"(H)
PACK: 2
WEIGHT: 4



FA-268
10"(W) x 10 1/2"(H)
PACK: 2
WEIGHT: 4

COUNTERTOP DISPLAYS- HANDBAG STAND

HANDBAG STAND - ROSE GOLD FINISH



CSR-GD1
HANDBAG DISPLAY
BASE: 4 3/4" x 6-1/4"
ADJUSTABLE UPRIGHT
FROM 14" - 26"
ROSE GOLD
PACK : 2
WT : 9



CSR-GD2
HANDBAG DISPLAY
BASE: 4 3/4" x 6-1/4"
ADJUSTABLE UPRIGHT
FROM 14" - 26"
ROSE GOLD
PACK : 2
WT : 9



CSR-HB
HANDBAG STAND
8" SQ. BASE
ADJUSTABLE UPRIGHT FROM 12" TO 22"
CHROME
PACK : 4
WT : 15

COUNTERTOP DISPLAYS- MULTI PURPOSE



SPCT2
2-TIER REVOLVING COUNTERTOP
28 1/2" x 17 1/2" x 12" BASE
6 HOOKS PER TIER- 8 1/2"
CHROME
PACK : 5
WT : 15



SPCT3
3-TIER REVOLVING COUNTERTOP
24"W x 30" H x 12" BASE
8 HOOKS PER TIER- 8 1/2"
CHROME
PACK : 5
WT : 19



SPCT2M
2-TIER REVOLVING COUNTERTOP
28 1/2" x 17 1/2" x 12" BASE
6 HOOKS PER TIER- 8 1/2"
CHROME
PACK : 5
WT : 21



SPCT3M
3-TIER REVOLVING COUNTERTOP
24"W x 30" H x 12" BASE
18 HOOKS PER TIER- 8 1/2"
CHROME
PACK : 5
WT : 23

COUNTERTOP- ACRYLIC DISPLAYS WITH METAL BASE

Item	Description	Color	Pack	Wt
------	-------------	-------	------	----



CSR-HD1 SINGLE - HORIZONTAL HEAD BAND DISPLAY
CYLINDER : 5-1/4"(D) DISC x 12"(L)
ADJUSTABLE UPRIGHT FROM 10" - 14"
BASE: 7"

BLACK

1 6



CSR-HD2 2-TIER - HORIZONTAL HEAD BAND DISPLAY
CYLINDER : 5-1/4"(D) DISC X 12"(L)
ADJUSTABLE UPRIGHT FROM 10" - 16"
BASE: 7" x 11"

BLACK

1 8



CSR-T1 SINGLE JEWELRY STAND
ADJUSTABLE UPRIGHT FROM 14" - 16"
BASE: 7"

BLACK

1 6



CSR-T3 3-TIER JEWELRY STAND
ADJUSTABLE UPRIGHT FROM 9" - 16"
BASE: 7"

BLACK

1 9



CSR-EUS COUNTERTOP JEWELRY DISPLAY- SQUARE
EASY TO OPEN SQUARE TOP
SQUARE: 7" x 7" x 7"
METAL STEM: 6"
METAL BASE: 7" x 7"

CHROME

1 9



CSR-EUR COUNTERTOP JEWELRY DISPLAY- DISC
OPEN DISC: 8"(D) & 1"(H)
METAL STEM: 6"
METAL BASE: 7" x 7"

CHROME

1 6

Item & Description

Color

Pack Wt

COUNTERTOP- ACRYLIC DISPLAYS- JEWELRY



NBD6
PACK: 10 WEIGHT: 11 LBS
2" DIAMETER TUBING BAR - 12", HEIGHT - 8 3/8"

NBD9
PACK: 10 WEIGHT: 13 LBS
2" DIAMETER TUBING BAR - 12", HEIGHT - 11 3/8"

NBD12
PACK: 10 WEIGHT: 15 LBS
2" DIAMETER TUBING BAR - 12", HEIGHT - 14 3/8"

NBD18
PACK: 10 WEIGHT: 19 LBS
2" DIAMETER TUBING BAR - 14", HEIGHT - 20 3/8"
BASE : 6" X 4" X 3/8"



CTP1328
SINGLE BRACELET BAR
- 18 1/2" HEIGHT
TUBING BAR: 5/8"(D) x 10"(L)
BASE: 4 3/4" x 3 3/4" x 1/4"(T)
ARM: 12"

CLEAR 24 11



CTP1330
DOUBLE BRACELET BAR
- 4 1/4" & 8 3/4" HEIGHT
TUBING BAR: 5/8"(D) x 10"(L)
BASE: 4 3/4" x 3 3/4" x 1/4"(T)
ARM: 12"

CLEAR 24 11



NBC-2
2-TIER ACCESSORY DISPLAY
11 3/4"(L) x 5"(W) x 6"(H)
1" DIAMETER BAR

CLEAR 5 6



NBC-3
3-TIER ACCESSORY DISPLAY
11 3/4"(L) x 6 1/2"(W) x 9 1/4"(H)
1" DIAMETER BAR

CLEAR 5 9

Item & Description

Color

Pack Wt

COUNTERTOP- ACRYLIC DISPLAYS- EYEWEAR



CT-SUF6
HOLDS 6 PAIRS

CLEAR 10 2

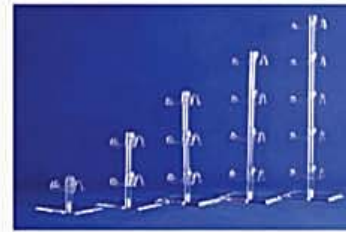

EWD1
1 TIER, 2 3/4" x 2 3/4" x 3/16"(BASE)
EWD2
2 TIER, 3 1/8" x 3 1/8" x 3/16"(BASE)
EWD3
3 TIER, 3 1/2" x 3 1/2" x 3/16"(BASE)
EWD4
4 TIER, 3 7/8" x 3 7/8" x 3/16"(BASE)
EWD5
5 TIER, 4 1/8" x 4 1/8" x 3/16"(BASE)

CLEAR 10 2
CLEAR 10 3
CLEAR 10 3
CLEAR 10 3
CLEAR 10 4

COUNTERTOP- ACRYLIC DISPLAYS- HEAD BANDS



HDH2
HORIZONTAL HEAD BAND DISPLAY
18 1/2"(H) x 20"(W) x 8"(D)
2 TIER
PACK: 1
WEIGHT: 4 LBS



HDH3
HORIZONTAL HEAD BAND DISPLAY
27"(H) x 20"(W) x 8"(D)
3 TIER
PACK: 1
WEIGHT: 6 LBS



HDH
HORIZONTAL HEAD BAND DISPLAY
6 1/2"(H) x 12"(W) x 6"(D)
PACK: 1
WEIGHT: 2 LBS



HDV
VERTICAL HEAD BAND DISPLAY
12"(H) x 6"(W) x 7"(D)
PACK: 4
WEIGHT: 7LBS

COUNTERTOP- ACRYLIC DISPLAYS- ACCESSORY BINS

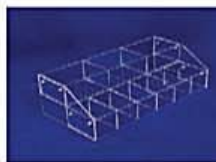

CTP1133
ACCESSORY BIN
16" x 8" x 4 5/8" x 1/8"(T)
PACK: 6
WEIGHT: 15 LBS



CTP1132
ACCESSORY BIN
16" x 8" x 4 5/8" x 1/8"(T)
PACK: 6
WEIGHT: 12 LBS

Item Description Color Pack Wt

ACRYLIC DISPLAYS - E -CIGARETTE

PLEASE SEE OUR
SHOWCASE COLLECTION
ON PAGES 65 - 72



EV1/R CURVED SINGLE SPACE ROUND BASE
ACRYLIC CONSTRUCTION
2 3/4" x 2 3/4" x 3 1/4"
5/8" SLOT

CLEAR 5 1



EV1/P ANGLED 2 SLOT STAND
ACRYLIC CONSTRUCTION
3 1/4" x 3 3/4" x 2 1/8"
11/16" SLOT

CLEAR 5 1



EV8 8 SLOTS 1 ROW DISPLAY
ACRYLIC CONSTRUCTION
8 1/4" x 2" x 2 3/4"
8 SLOTS: 5/8"

CLEAR 3 1



EV18 3 ROW E-CIG LIQUID BOTTLE DISPLAY
ACRYLIC CONSTRUCTION
7-1/4" X 5"
18 SLOTS : 1" DIAMETER

CLEAR 3 1



EV24 2-TIER ACRYLIC E-CIG LIQUID
BOTTLE DISPLAY
ACRYLIC CONSTRUCTION
7 7/8" x 5 1/4" x 2 1/8"
24 SLOTS: 1" DIAMETER

CLEAR 3 1

Item & Description Color Pack Wt

COUNTERTOP- ACRYLIC DISPLAYS- HEADPHONE



HP/1
HEADPHONE DISPLAY
HEIGHT: 10"
PACK: 1
WEIGHT: 2 LBS

COUNTERTOP- ACRYLIC DISPLAY- BUSINESS CARD HOLDER



SPH32
BUSINESS CARD HOLDER
3 1/2"(W) x 2"(H) x 5/64"(T)

CLEAR 25 5

COUNTERTOP- ACRYLIC DISPLAY- LITERATURE HOLDER



LHBC
LITERATURE W/ BUSINESS HOLDER
8 1/2"(W) x 11"(H) x 5/64"(T)

CLEAR 1 1



CTP201
LITERATURE HOLDER
4 1/4"(W) x 3/32"(T)

CLEAR 6 5



CTP216
LITERATURE HOLDER
9"(W) x 3/32"(T)

CLEAR 6 6

COUNTERTOP- ACRYLIC DISPLAY- LITERATURE HOLDER



FSH
SINGLE FOLDED SHIRT
10"(L) x 6 1/4"(W) x 11 1/4"(H) x 5/64"(T)

CLEAR 1 1

COUNTERTOP- ACRYLIC DISPLAY- CLUTCH BAG HOLDER



CBD
CLUTCH BAG
11 1/8"(L) x 4"(W) x 8 1/4"(H)
2 1/2" SPACES

CLEAR 1 2

COUNTERTOP- ACRYLIC DISPLAY- CELL PHONE HOLDER



CHA-L
CELL PHONE
4.8"(L) x 2.5"(W) x 3.5"(H)

CLEAR 100 12

COUNTERTOP- ACRYLIC DISPLAYS

Item	Description	Color	Pack	Wt
FC4G-10		FROSTED 4-SIDED CUBE 10"	1	15
FC4W-10		FC4G-10 10" x 10" x 10" COLOR: GREEN FC4W-10 COLOR: WHITE	1	15
FC4G-12		FROSTED 4-SIDED CUBE 12"	1	16
FC4W-12		FC4G-12 12" x 12" x 12" COLOR: GREEN FC4W-12 COLOR: WHITE	1	16

COUNTERTOP- ACRYLIC DISPLAYS- 5 SIDED CUBES



5 SIDED CUBES:
COLOR: CLEAR

FSC8
PACK: 1 WEIGHT: 2 LBS
8" X 8" X 8", 5/32" THICKNESS

FSC10
PACK: 1 WEIGHT: 3 LBS
10" X 10" X 10", 5/32" THICKNESS

FSC12
PACK: 1 WEIGHT: 5 LBS
12" X 12" X 12", 5/32" THICKNESS

FSC15
PACK: 1 WEIGHT: 7 LBS
15" X 15" X 15", 5/32" THICKNESS

COUNTERTOP- ACRYLIC DISPLAYS



CRS-IP-R **CRS-IP-S**

1-SIDED OPEN ENDED ROUND
COLOR: CLEAR
CRS-IP-R
HEIGHT: 10"
BASE DIA: 10"
PACK : 1
WT : 3

1-SIDE OPEN ENDED SQUARE
COLOR: CLEAR
CRS-IP-S
HEIGHT: 10"
BASE DIA: 10"
PACK : 1
WT : 3



FRT8
PACK: 1 WEIGHT: 1 LBS
8" X 8", 5/32" THICKNESS

FRT10
PACK: 1 WEIGHT: 1 LBS
10" X 10", 5/32" THICKNESS

FRT12
PACK: 1 WEIGHT: 1 LBS
12" X 12", 5/32" THICKNESS

COUNTERTOP- ACRYLIC DISPLAYS- RISERS



U-SHAPED RISER- SET OF 5
CTP1104
COLOR: BLACK
1: 13"L x 4 1/2"W x 6"H
2: 12"L x 4 1/2"W x 5"H
3: 11"L x 4 1/2"W x 4"H
4: 10"L x 4 1/2"W x 3"H
5: 9"L x 4 1/2"W x 2"H
THICKNESS: 1/4"



CTP1101
SET OF 3 RECTANGULAR DISPLAY RISERS - 1/8" T
1: 3 3/4"(L) x 2"(W) x 2 1/4"(H)
2: 3 1/4"(L) x 2"(W) x 1 3/4"(H)
3: 2 3/4"(L) x 2"(W) x 1 1/4"(H)



CTP1102
SET OF 3 RECTANGULAR DISPLAY RISERS - 1/8" T
1: 7 1/4"(L) x 4"(W) x 4 1/2"(H)
2: 6 1/4"(L) x 4"(W) x 3 1/2"(H)
3: 5 1/4"(L) x 4"(W) x 2 1/2"(H)



CTP1103
SET OF 5 SQUARE DISPLAY RISERS - 1/8" T
1: 5"(L) x 5"(W) x 5"(H)
2: 4"(L) x 4"(W) x 4"(H)
3: 3"(L) x 3"(W) x 3"(H)
4: 2"(L) x 2"(W) x 2"(H)
5: 1"(L) x 1"(W) x 1"(H)



86-502CL
PLEXI "U" RISER SET OF 3 - 1/8" THICKNESS
1: 5"(L) x 5"(W) x 5"(H)
2: 4"(L) x 4"(W) x 4"(H)
3: 3"(L) x 3"(W) x 3"(H)



86-503CL
PLEXI "U" RISER SET OF 3 - 1/4" THICKNESS
6"(L) x 63"(W) x 6"(H)
8"(L) x 8"(W) x 8"(H)
10"(L) x 10"(W) x 10"(H)

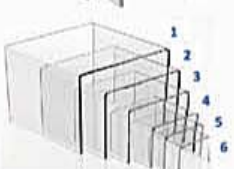

86-505CL
PLEXI "U" RISER SET OF 6 - 3/16" THICKNESS
1: 12"(L) x 12"(W) x 12"(H)
2: 10"(L) x 10"(W) x 10"(H)
3: 8"(L) x 8"(W) x 8"(H)
4: 6"(L) x 6"(W) x 6"(H)
5: 5"(L) x 5"(W) x 5"(H)
6: 4"(L) x 4"(W) x 4"(H)

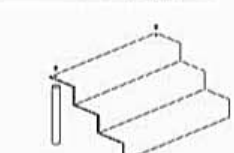

CTP1250
RISER - 9" x 6" x 6" - 1/8" THICKNESS
3" DEEP SHELVES

CTP1252
RISER - 12" x 9" x 9" - 1/8" THICKNESS
3" DEEP SHELVES

CTP1253
RISER - 18" x 9" x 9" - 1/8" THICKNESS
3" DEEP SHELVES

COUNTERTOP- ACRYLIC DISPLAYS- EASELS



Item & Description	Color	Pack	Wt
EASEL-1 2"(W) x 3"(H)	CHROME	25	1
EASEL-2 3 1/2"(W) x 4 1/2"(H)	CHROME	25	1
EASEL-3 5"(W) x 6 1/2"(H)	CHROME	25	1
EASEL-4 3 3/4"(W) x 9 1/4"(H)	CHROME	25	1
EASEL-5 3 3/4"(W) x 4 3/4"(H)	CHROME	25	1



85-101CL	ACRYLIC EASEL 3 1/2"(W) x 4"(H) x 1"(D) OPENING	CLEAR	25	5
-----------------	--	-------	----	---



85-102CL	ACRYLIC EASEL 5-1/2"(W) x 6"(H) x 1"(D) OPENING	CLEAR	25	13
-----------------	--	-------	----	----

COUNTERTOP- ACRYLIC DISPLAYS- SIGN HOLDERS



SHPK57	7"(W) x 5 1/2"(H) CLEAR SIGN HOLDER W/METAL BASE	CLEAR & METAL BASE	24	29
---------------	---	-----------------------	----	----



SHPK711	7"(W) x 5 1/2"(H) CLEAR SIGN HOLDER W/METAL BASE	CLEAR & METAL BASE	24	41
----------------	---	-----------------------	----	----



HP/CT57H	LANDSCAPE COUNTERTOP SIGN HOLDER - TOP INSERT 7"(W) x 5"(H)	CLEAR	48	11
-----------------	---	-------	----	----



HP/CT/118	LANDSCAPE COUNTERTOP SIGN HOLDER - TOP INSERT 8 1/2"(W) x 11"(H)	CLEAR	48	22
------------------	--	-------	----	----

COUNTERTOP- ACRYLIC DISPLAYS- SIGN HOLDERS



Item	Description	Color	Pack	Wt
HP/CT57H-BL	PORTRAIT COUNTERTOP SIGN HOLDER BOTTOM INSERT 7"(W) x 5"(H)	CLEAR	48	11



HP/CT/118-BL	PORTRAIT COUNTERTOP SIGN HOLDER BOTTOM INSERT 8 1/2"(W) x 11"(H)	CLEAR	48	22
---------------------	--	-------	----	----



SHP1131	PORTRAIT SIGN HOLDER 5 1/2"(W) x 7"(H) - 3/32" THICKNESS	CLEAR	25	9
----------------	---	-------	----	---



SHP1133	7"(W) x 11"(H) - 3/32" THICKNESS	CLEAR	25	17
----------------	----------------------------------	-------	----	----



SHP1135	8 1/2"(W) x 11"(H) - 3/32" THICKNESS	CLEAR	25	21
----------------	--------------------------------------	-------	----	----



SHP1132	LANDSCAPE SIGN HOLDER 7"(W) x 5-1/2"(H) - 3/32" THICKNESS	CLEAR	25	9
----------------	--	-------	----	---



SHP1134	11"(W) x 7"(H) - 3/32" THICKNESS	CLEAR	25	17
----------------	----------------------------------	-------	----	----



SHP1136	11"(W) x 8 1/2"(H) - 3/32" THICKNESS	CLEAR	25	21
----------------	--------------------------------------	-------	----	----

COUNTERTOP MIRRORS



MRL-D	DOUBLE MIRROR SIZE - 8 1/2" x 10 1/2" BASE SIZE - 6" x 6" OVERALL HEIGHT - 16 1/2"	CHROME	1	8
--------------	--	--------	---	---



MIRROR-E07	SINGLE SIDED ROUND MIRROR 8 1/2"(H)	BLACK	24	31
-------------------	--	-------	----	----



JB-1004	DOUBLE SIDE SQUARE MIRROR 8"(L) x 10"(H)	CLEAR	12	25
----------------	---	-------	----	----



JB-1008	DOUBLE SIDE OVAL MIRROR 8"(L) x 10"(H)	CLEAR	12	25
----------------	---	-------	----	----

COUNTERTOP- GLASS SHOWCASES

Item & Description	Color	Pack	Wt
 F-1301 F-1301(B) GLASS SHOWCASE W/SHELVES LOCK & KEYS INCLUDED 24"(L) x 12"(W) x 18"(H)	SILVER BLACK	1 1	19 19
 F-1302 F-1302(B) GLASS SHOWCASE W/SHELVES LOCK & KEYS INCLUDED 14"(L) x 12"(W) x 27"(H)	SILVER BLACK	1 1	17 17
 F-1303 F-1303(B) GLASS SHOWCASE LOCK & KEYS INCLUDED 30"(L) x 18"(W) x 9"(H)	SILVER BLACK	1 1	18 18









COUNTERTOP- ACRYLIC SHOWCASES

 ACT/3 Locking 3 Shelf Showcase 13"L x 7 1/2"W x 21"H PACK: 1 WT: 18 LBS.	 ACTL/2 Locking 2 Shelf Showcase 21"L x 7 1/2"W x 13"H PACK: 1 WT: 14 LBS.
 ACLC Locking Showcase 24"L x 18"W x 3"H PACK: 1 WT: 8 LBS.	





COUNTERTOP- SLATWALL MERCHANDISER

 WD2CT MAPLE PACK: 1 WEIGHT: 15	 WD4R-CT MAPLE PACK: 1 WEIGHT: 15	 WD4S-CT MAPLE PACK: 1 WEIGHT: 15
--	--	--





COUNTERTOP- ECONOMY WIRE DISPLAY

Item	Description	Color	Pack	Wt
 MS1B	COUNTERTOP MERCHANDISE SPINNER 14 3/16"(W) x 25 1/2"(H) SLOPES FROM 3 1/2" to 5"(H) 10PCS OF 8" HOOKS INCLUDED	BLACK	2	20
 SPR2	COUNTERTOP SPINNER 30"(H) x 12" BASE 6" PRONGS WITH 7 1/2" SPACE BETWEEN TIERS 12" APART INCLUDES SIGNHOLDER See Floor Economy Wire Displays on page 114	CHROME	1	4
 FCAP6	COUNTERTOP CAP TOWER 10"L x 15 1/2"W x 38"H HOLDS UP TO 36 CAPS See Floor Economy Wire Displays on page 114	BLACK	1	20
 CTCAP4	COUNTERTOP CAP HOLDER CAN HOLD UP TO 48 CAPS ON 4 TIERS 9 1/4"(W) x 16"(D) x 20"(H)	BLACK	1	5
 SPCAP2	COUNTERTOP CAP DISPLAY TWO ROTATING TIERS INCLUDES SIGNHOLDER HOLDS UP TO 96 CAPS ON 2 TIERS BLACK BASE FINISH See Floor Economy Wire Displays on page 114	BLACK	1	10
 SPHAT2	COUNTERTOP MILLINERY DISPLAY 34"(H) x 12" BASE 8 SPONGES INCLUDES SIGNHOLDER BLACK BASE FINISH	CHROME	1	5
 SPLIT2	COUNTERTOP MAGAZINE SPINNER 28"(H) x 2"(D) POCKETS 12" BASE INCLUDES SIGNHOLDER See Floor Economy Wire Displays on page 115	CHROME/ BLACK	1	7
 CTSHF3	CTSHF3 COUNTERTOP 3 TIER MULTI PURPOSE DISPLAY 24"(W) x 13"(H) x 15"(D)	BLACK	1	8
 CTSHF6	CTSHF6 COUNTERTOP 6 TIER MULTI PURPOSE DISPLAY 30"(W) x 22"(H) x 19"(D) FOLDS FOR STORAGE	BLACK	1	8

GARMENT RACKS- 1" SQUARE TUBING RACKS- 4 WAY

Item	Description	Color	Pack	Wt
 R10	1" SQ. TUBING 4-WAY W/ STRAIGHT SQ. TUBE ARMS 4 - 16" STRAIGHT ARMS TEAR DROP END CAPS	CHROME	1	30
 R12	1" SQ. TUBING 4-WAY W/ STRAIGHT & SLANT ARMS 2 - 16" STRAIGHT ARMS 2 - 18" SLANT ARMS 8 BALLS TEAR DROP END CAPS	CHROME	1	30
 R13 R13MAB R13-SC	1" SQ. TUBING 4-WAY W/ STRAIGHT BLADE ARMS 4 - 16" 1/2" x 1-1/2" RECT. TUBING STRAIGHT ARMS	CHROME MATTE BLK SATIN CHROME	1 1 1	30 30 30
 R14	1" SQ. TUBING 4-WAY W/ SLANT ARMS 4 - 16" 1/2" x 1-1/2" RECT. TUBING SLANT ARMS 8 BALLS	CHROME	1	30
 R15	1" SQ. TUBING 4-WAY W/SLANT ARMS 4 - 18" 1/2" x 1 1/2" SQ. TUBE SLANT ARMS 8 BALLS	CHROME	1	30

GARMENT RACKS- 1" SQUARE TUBING RACKS- 2 WAY

 R20	1" SQ. TUBING 2-WAY W/ STRAIGHT ARMS 2 - 16" STRAIGHT SQ. TUBE ARMS	CHROME	1	30
 R25	1" SQ. TUBING 2-WAY W/ 2-SLANT ARMS 2 - 18" SQ. TUBE SLANT ARMS WITH 8 BALLS 15"(L) x 12"(W) HEAVY WEIGHTED BASE	CHROME	1	30
 R22	1" SQ. TUBING 2-WAY W/ 1 STRAIGHT & 1 SLANT ARM 1 - 16" STRAIGHT SQ. TUBE ARM 1 - 18" SLANT SQ. TUBE ARM WITH 8 BALLS 15"(L) x 12"(W) HEAVY WEIGHTED BASE	CHROME	1	30
 R23 R23/MAB	1" SQ. TUBING 2-WAY W/ STRAIGHT BLADE ARMS 2 - 16" 1/2" x 1-1/2" RECT. TUBING STRAIGHT ARMS 15"(L) x 12"(W) HEAVY WEIGHTED BASE	CHROME MATTE BLK	1 1	30 30





GARMENT RACKS- 1" SQUARE TUBING RACKS- 2 WAY

 R23RT-SC	1" SQ. TUBING 2-WAY W/ STRAIGHT BLADE ARMS RECTANGULAR TUBING UPRIGHT 2 - 16" 1/2" x 1-1/2" RECT. TUBING STRAIGHT ARMS 15"(L) x 12"(W) HEAVY WEIGHTED BASE	SATIN CHROME	1	30
 R24	1" SQ. TUBE 2-WAY W/ SLANT BLADE ARMS 2 - 16" 1/2" x 1-1/2" RECT. TUBING SLANT ARMS 8 BALLS 15"(L) x 12"(W) HEAVY WEIGHTED BASE	CHROME	1	30

SQUARE TUBING ADD-ON ARMS

 TV12-CH	12" TWIST-ON STRAIGHT ARM FOR R10'S & R20'S	CHROME	25	17
 TV16-CH	16" TWIST-ON STRAIGHT ARM FOR R10'S & R20'S 3/4" SQUARE TUBING FACEOUT	CHROME	25	21
 TV17-CH	16" TWIST-ON STRAIGHT ARM FOR R10'S & R20'S 1/2" x 1-1/2" RECTANGULAR TUBING FACEOUT	CHROME	25	31







HIGH CAPACITY RECTANGULAR TUBING RACKS

 R80	SUPER QUAD RECT. TUBE 4-WAY 4 - 22" STRAIGHT ARMS 5/8" x 1 5/8" RECT. TUBE FRAME 3/8" FITTING FOR SIGNHOLDER	CHROME	1	36
 R80 X 16 R80 X 16-SC	SUPER QUAD RECT. TUBE 4-WAY 4 - 16" STRAIGHT ARMS 5/8" x 1 5/8" RECT. TUBE FRAME 3/8" FITTING FOR SIGNHOLDER	CHROME SATIN CHROME	1 1	35 35
 R85 R85-SC	RECT. TUBE 4-WAY W/ 4-16" STRAIGHT ARMS 5/8" x 1 5/8" RECT. TUBE FRAME 3/8" FITTING FOR SIGNHOLDER	CHROME SATIN CHROME	1 1	32 32
 R66N	6 WAY RACK 6 - 16" STRAIGHT ARMS 5/8" x 1 5/8" RECT. TUBE FRAME WITH 6 LEVELERS	CHROME	1	52



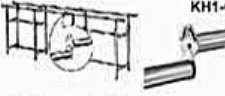

RECTANGULAR TUBING ADD-ON ARMS

 RV16	16" TWIST-ON STRAIGHT ARM FOR R85 & R80 X 16	CHROME	25	33
 RV22	22" TWIST-ON STRAIGHT ARM FOR R80 ** ADD-ON ARMS FOR R80'S AND R85'S	CHROME	25	41









H RACKS & ACCESSORIES

Item	Description	Color	Pack	Wt
	R40 STANDARD H-RACK 60" HANGRAIL x 22" WIDE	CHROME	1	40
	R40 MIRROR MIRROR FOR R40 & R41 19" W x 58" H	 MIRROR	1	40
	R41 "H" RACK W/ V-BRACE 60" HANGRAIL x 22" WIDE	CHROME	1	42
	01-008CH 22"W X 54"L FOLDING TOP BASKET FOR H RACKS - R40 & R41	CHROME	1	16
	KH1-CH 60" EXTENSION HANGRAIL FOR R40 & R41	CHROME	10	43
	KH2-CH 60" DOUBLE HANGRAIL W/ CLAMP FOR R40 & R41	CHROME	10	46
	KHZ SUPPORT Z BRACE FOR DOUBLE HANGRAIL RACK- R40	CHROME	10	37

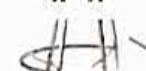





ROUND RACKS

	R52WD R57WD 36" DIA ROUND FOLDING RACK W/ 1 1/4" ROUND RING 42" DIA ROUND FOLDING RACK W/ 1 1/4" ROUND RING HEIGHT IS ADJUSTABLE EVERY 3" FROM 48" TO 66" UPRIGHTS ARE MADE OF 1" SQUARE TUBING 4 - TOP SHELF SUPPORT INCLUDED	CHROME CHROME	1 1	35 42
	R52WD/MAB 36" DIA ROUND FOLDING RACK W/ 1 1/4" ROUND RING HEIGHT IS ADJUSTABLE EVERY 3" FROM 48" TO 66" UPRIGHTS ARE MADE OF 1" SQUARE TUBING FINISH: RING - CHROME & FRAME - MATTE BLACK 4 - TOP SHELF SUPPORT INCLUDED	MATTE BLK	1	35
	R71WD R73WD 36" DIA ROUND FOLDING RACK 42" DIA ROUND FOLDING RACK 1/2" x 1 1/2" RECT. RING UPRIGHTS ARE MADE OF 1" SQUARE TUBING FINISH: RING - CHROME 4 - TOP SHELF SUPPORT INCLUDED	CHROME CHROME	1 1	38 42
	R71WD - SC 36" DIA ROUND FOLDING RACK 1/2" x 1 1/2" RECT. RING UPRIGHTS ARE MADE OF 1" SQUARE TUBING FINISH: RING - CHROME 4 - TOP SHELF SUPPORT INCLUDED	SATIN CHROME	1	38

ROUND RACKS - ACCESSORIES

Item	Description	Color	Pack	Wt
	30GK52 30" ROUND x 3/16" TEMPERED GLASS	GLASS	2	23
	36GK57 36" ROUND x 3/16" TEMPERED GLASS	GLASS	2	34
	00-013CH 30" ROUND BASKET FOR TOP OF ROUND RACKS - R52WD & R57WD & R71WD & R73WD	CHROME	1	8
	KH5-CH ADD ON 36" DIAMETER ROUND HANGRAIL	CHROME	5	36
	KH6-CH ADD ON 42" DIAMETER ROUND HANGRAIL	CHROME	5	41
	KH8-CH ADD ON 36" DIAMETER RECTANGULAR HANGRAIL	CHROME	5	36
	KH9-CH ADD ON 42" DIAMETER RECTANGULAR HANGRAIL	CHROME	5	41
	KH7-CH ADD ON BRACKET FOR ROUND RACKS - 4EA/SET	CHROME	5	6
	4PIN TOP SHELF SUPPORT - 4EA/SET	CHROME	1SET	1

ROLLING RACKS & ACCESSORIES

	RCS/1-CH HEAVY DUTY COLLAPSIBLE ROLLING RACK 48" HANGRAIL AND 2 - 12" PULL-OUT RODS 4" WHEELS	CHROME	1	28
	RCS/2-CH HEAVY DUTY COLLAPSIBLE DOUBLE ROLLING RACK 2 - 48" HANGRAIL AND 4 - 12" PULL-OUT RODS 22" WIDE 4" WHEELS	CHROME	1	35
	R43 SQ. TUBING SINGLE HANGRAIL ROLLING RACK 60" HANGRAIL x 20" WIDE 1 1/4" ROUND TUBING HANGRAIL	CHROME	1	27
	RZ/1 Z RACK - SQUARE TUBING (WELDED) RZ/1 (K/D) Z RACK - SQUARE TUBING (KNOCK DOWN) 59" HANGRAIL x 68" HEIGHT BLACK FRAME BASE	CHROME CHROME	1 1	35 35
	RZH/60 60" ADD-ON HANGRAIL FOR RZ/1 ROLLING RACK	CHROME	10	37
	RZE/12-CH 12" HEIGHT EXTENSION FOR RZ/1	CHROME	10	15

SPECIALTY RACKS

Item & Description

Color

Pack

Wt

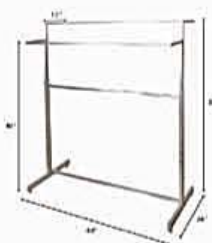

BB/4B
BI-LEVEL ADJUSTABLE HEIGHT RACK
ADJ. HEIGHT EVERY 3" FROM 49" - 73"
BASE: 24"D & HANGRAIL: 48"L x 12"D
SATIN CHROME FINISH
PACK: 1
WEIGHT: 36



BB/1
BALLET BAR RACK
ADJ. HEIGHT EVERY 3" FROM 49" - 73"
24"(L) x 33"(W) x 48"(H)
SATIN CHROME FINISH
PACK: 1
WEIGHT: 25



BB/4
BALLET BAR RACK- 4 WAY
ADJ. HEIGHT EVERY 3" FROM 49" - 73"
BASE: 24" & ARMS: 15"L
SATIN CHROME FINISH
PACK: 1
WEIGHT: 30



R62
HALF ROUND RACK - 43" DIAMETER
ADJ. HEIGHT EVERY 3" FROM 49" - 73"
1 1/4" HANGRAIL
CHROME FINISH
PACK: 1
WEIGHT: 25



R29
SPIRAL RACK
65" HEIGHT
29 BALLS
18 1/2" BASE

CHROME

1

23



RSB54
54" SINGLE HANGRAIL DISPLAYER

CHROME

1

16

RSB63
63" SINGLE HANGRAIL DISPLAYER

CHROME

1

17

56" CHROME HANGRAIL WITH BLACK UPRIGHT



R36
FOLDING LINGERIE TOWER
- SQUARE TUBING W/ARMS
60" HEIGHT
16 - 3/8" x 12"(L) SQUARE TUBING TWIST
- ON ARMS

CHROME

1

35

Item

Description

Color

Pack

Wt

SPECIALTY RACKS



R26

HAT DISPLAYER - 5 TIER SINGLE UPRIGHT
67" HEIGHT
20 HATS CAPACITY
18 1/2" BASE

CHROME

1

38



R58

1 TIER REVOLVING BELT/TIE RACK
52" HEIGHT
20 - 3" HOOKS
18 1/2" BASE

CHROME

1

33



R56

TWO TIER REVOLVING BELT/TIE RACK
54" HEIGHT
UPPER LEVEL 20 - 3" HOOKS
LOWER LEVEL 28 - 3" HOOKS
18 1/2" BASE

CHROME

1

40



R98

TWO TIER ADJUSTABLE BELT/TIE RACK
63" TO 72" HEIGHT
UPPER LEVEL 16 - 3" HOOKS
LOWER LEVEL 32 - 3" HOOKS
15 1/2" x 20 1/4" BASE

CHROME

1

50

CASTERS



TW10

2" PLASTIC TWIN WHEEL CASTER
W/ BLACK HOOD

BLACK

4

5

TW10/B

2" PLASTIC TWIN WHEEL CASTER
W/ BLACK HOOD AND BRAKE

BLACK

4

5

3/8" & 5/16" THREADS AVAILABLE



HDC3

3" HEAVY DUTY CASTER - 3/8" THREAD

BLACK

1

1

HDC3/B

3" HEAVY DUTY CASTER WITH BRAKE
- 3/8" THREAD

BLACK

1

1

PL-CASTER

3" HEAVY DUTY CASTER - 1/2" THREAD

BLACK

1

1

PL-CASTERNB

3" HEAVY DUTY CASTER WITHOUT BRAKE
- 1/2" THREAD WITH BLACK HOOD

BLACK

1

1

FITS WITH OUR PIPELINE COLLECTION



SHOE RACKS



Item & Description	Color	Pack	Wt
SHOERACK TWO SIDED SHOE RACK 8 - 48"(L) x 12"(W) SHELF 58" HEIGHT HOLDS APPROXIMATELY 40-56 WOMEN'S SHOES	CHROME	1	65



SHOERACK/2 FOLDING SHOE RACK FOR EASY STORAGE 12 - 48"(L) x 12"(W) SHELF 61" HEIGHT 2 LOCKING AND 2 NON-LOCKING CASTERS INCLUDED HOLDS APPROXIMATELY 144-168 WOMEN'S SHOES SIGNHOLDER SOLD SEPARATELY- PAGE 136	CHROME	1	75
--	--------	---	----

SHOE BENCH STOOLS



SFB SHOE BENCH W/MIRROR 30"(L) x 14"(W) x 19"(H)	CHROME	1	20
---	--------	---	----



SS SHOE BENCH STOOL 31 1/2"(L) x 10"(W) x 14"(H)	CHROME	1	13
---	--------	---	----



SMD-12 SHOE MIRROR FOR FLOOR 12"(L) x 18"(H)	CHROME	1	10
---	--------	---	----

SHOE DISPLAY ACCESSORIES



ASF SHOE FORM-ACRYLIC	CLEAR	25	22
---------------------------------	-------	----	----



ASF2 SHOE FORM-ACRYLIC	CLEAR	25	22
----------------------------------	-------	----	----

SHOE DISPLAY ACCESSORIES



CSR-MS MIRROR SHOE DISPLAY- SINGLE 10"(L) x 3"(W) x 4"(H) FITS UP TO WOMEN'S SIZE 8 SHOES	MIRROR	2	5
---	--------	---	---



CSR-MSP MIRROR SHOE DISPLAY- DOUBLE 10"(L) x 8"(W) x 3"(H) FITS UP TO WOMEN'S SIZE 8 SHOES	MIRROR	2	5
--	--------	---	---



CSR-SS ADJUSTABLE SHOE RISER BASE SIZE - 6" x 4" ADJUSTABLE FROM 14" TO 22"	CHROME	1	4
---	--------	---	---



CSR-8 SHOE DISPLAY - HEIGHT: 8", BASE SIZE- 3 1/2" x 7"	CHROME	1	3
CSR-10 SHOE DISPLAY - HEIGHT: 8", BASE SIZE- 3 1/2" x 7"	CHROME	1	4
CSR-12 SHOE DISPLAY - HEIGHT: 8", BASE SIZE- 3 1/2" x 7"	CHROME	1	5



CTP1205 SET OF 3 BEVELED EDGE SLANT SHOE RISERS 1: 7"(H) - 3/16" THICKNESS 2: 6"(H) - 3/16" THICKNESS 3: 5"(H) - 3/16" THICKNESS	CLEAR	6	4
---	-------	---	---



CTP-19 SHOE DISPLAY 8"(L) x 3"(H) x 3/32"(T)	CLEAR	24	4
---	-------	----	---

CTP-20 SHOE DISPLAY 8"(L) x 4"(H) x 3/32"(T)	CLEAR	24	5
---	-------	----	---

IMPULSE WIRE DISPLAYS



GTC36-CH CHROME
GTC36-BLK BLACK
GTC36-WTE WHITE
 DUMP BIN W/ 2" CASTERS
 2 LOCKING & 2 NON- LOCKING BRAKES
 ADJUSTABLE WIRE BOTTOM
 38"(L) x 38"(W) x 34 3/4"(H)

Pack Wt

1 80
 1 80
 1 80



3365B
 3-TIER BIN- SQUARE
 19"(D) x 47"(H)
 BASKET HEIGHT 6 1/2" & 16" DIAMETER

BLACK

1 30



4454B
 4-TIER BIN- ROUND
 12"(D) x 54 1/2"(H)
 BASKET HEIGHT 6 1/2" & 12" DIAMETER

BLACK

1 20

SEE OUR SHOPPING BASKETS ON PAGE. 129



3332W
 3-TIER BIN- ROUND
 18"(D) x 45"(H)
 BASKET HEIGHT 7" & DIAMETER IS 18"

WHITE

1 24

3332B

BLACK

1 24



SPBAS4
 SPINNING BASKET FLOOR RACK
 66"(H) x 22"(W)
 4 BASKETS - 21 3/4"(W) x 7"(D)

BLACK

1 10



SB5
 5 TIER STACKING BASKET- COLLAPSIBLE
 24"(L) x 25"(W) x 50"(H)
 5 BINS & 5 HORIZONTAL ADJUSTABLE BIN DIVIDERS
 INCLUDES FOUR 4" CASTERS:
 2 LOCKING & 2 NON-LOCKING BRAKES

WHITE

1 74



SB4
 4 TIER STACKING BASKET
 24"(L) x 21"(W) x 43"(H)
 4 BINS
 INCLUDES FOUR 4" CASTERS:
 2 LOCKING & 2 NON-LOCKING BRAKES

CHROME

1 40

IMPULSE WIRE DISPLAYS: CONVENIENCE STORE DISPLAYS



SPBS3
 MOBILE 3 TIER SQUARE WIRE BASKET RACK
 19 1/2"L x 19 1/2"W x 50"H
 BASKETS - 19 1/2"W x 6"D
 BASKETS DO NOT SPIN
 INCLUDES SIGNHOLDER
 2 BRAKE AND 2 NON-BRAKE CASTERS

SILVER EPOXY



1 18



SPMB3
 BLACK 3 TIER SQUARE WIRE BASKET RACK
 22 1/2"L x 18"W x 49"H
 LARGE BASKETS - 16"W x 7"D x 17 1/2"H
 BASKETS ARE REMOVABLE
 ADJUST BASKETS- STRAIGHT/TILT POSITION
 2 BRAKE AND 2 NON-BRAKE CASTERS

BLACK



1 22



SPRB5
 BLACK 5 TIER WIRE BASKET RACK
 FRAME SIZE: 24"L x 18"W x 58"H
 4 SLANTED BASKETS: 18" x 15" x 8"
 LARGE SLANTED BOTTOM BASKET: 28" x 18 1/2" x 8"
 2 BRAKE AND 2 NON-BRAKE CASTERS

BLACK



1 52

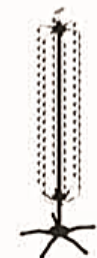

CPSD
 ROTATING FLOOR STRIP SPINNER RACK W/ 108 CLIPS
 18"W x 61"H
 6 LINES OF STRIPS WITH 18 STRONG CLIPS
 SIGNHOLDER INCLUDED

BLACK



1 14



CPCT
 TWO-SIDED COUNTER TOP DISPLAY W/ 39 CLIPS
 15"W x 24"H
 BASE: 9 1/2"L x 15W
 3 LINES OF STRIPS WITH 1 SIDE: 7 & 1 SIDE 6 CLIPS

WHITE



1 4



289-12CW
 12 CLIP WAND RETAILERS

IVORY

50 20

WICKER BASKET DISPLAYS: CONVENIENCE STORE DISPLAYS



WKSBL
Black Stackable Wicker Display
Overall: 13L x 9 1/2"W x 6 1/2"H x 5/32"T
Synthetic PP Basket: 12"L x 9"W x 3 1/2"H
Signage Space: 1 1/4"H
Spacing Between Slacks: 4 1/2"
Pk: 1 Wt: 2



WKRO3
Black 3-Tier Wicker Basket Display
Overall: 20"L x 13 1/8"W x 42"H
Synthetic PP Basket: 15"D x 7"H
Includes 2 locking and 2 non-locking
Pk: 1 Wt: 17



WKOV3
Black 3-Tier Oval Wicker Basket Display
Overall: 23"L x 18"W x 43 1/4"H
Synthetic PP Basket: 22"L x 17"W x 6" H
Includes 2 locking and 2 non-locking
Pk: 1 Wt: 29



WH-BASKET
Rectangular Polypropylene
Washable Wicker Baskets/Basket
Size: 12"L x 12"W x 6 1/2" H
Pk: 4 Wt: 1



WH1T4B
1 Tier Display
Overall: 50"L x 13 3/4"W x 13 1/2"H
Synthetic PP Basket:
12"L x 12"W x 6 1/2" H
Includes 4 washable wicker baskets
Includes 2 locking and 2 non-locking
casters
Pk: 1 Wt: 16



WH2T4B
2 Tier Display
Overall: 50"L x 13 13/4"W x 23 1/2"H
Synthetic PP Basket:
12"L x 12"W x 6 1/2" H
Includes 4 washable wicker baskets
Includes 2 locking and 2 non-locking
casters
Pk: 1 Wt: 26

Satin Chrome & Maple S.W SLATWALL MERCHANDISER

2-SIDED SLATWALL MERCHANDISER



SM1
1EA PANEL - 25"(L) x 25"(W) x 54"(H)
SATIN NICKEL FRAME STANDARD W/ ALUMINUM INSERTS
INCLUDES 2 LOCKING & 2 W/O LOCKING 3" H.D CASTERS
PACK: 1 / WT: 84

PINWHEEL MERCHANDISER



SM2
4 PANELS - 25"(L) x 25"(W) x 54"(H)
SATIN NICKEL FRAME STANDARD W/ ALUMINUM INSERTS
INCLUDES 2 LOCKING & 2 W/O LOCKING 3" H.D CASTERS
PACK: 1 / WT: 154

H-RACK MERCHANDISER



SM4
3 PANELS - 25"(L) x 25"(W) x 54"(H)
SATIN NICKEL FRAME STANDARD W/ ALUMINUM INSERTS
INCLUDES 2 LOCKING & 2 W/O LOCKING 3" H.D CASTERS
PACK: 1 / WT: 150







GONDOLA SLATWALL MERCHANDISER



SM5
3 PANELS - 50"(L) x 25"(W) x 54"(H)
SATIN NICKEL FRAME STANDARD
W/ ALUMINUM INSERTS
INCLUDES 2 LOCKING
& 2 W/O LOCKING 3" H.D CASTERS
PACK: 1 / WT: 213

SEE ADDITIONAL ACCESSORIES ON PG. 77 ~ 83



BAG HOLDER & SHOPPING BASKETS

Item & Description	Color	Pack	Wt
 <p>SBHD BAG HOLDER 12 1/2"L x 12 1/2"W x 14"H</p>	CHROME	4	23
 <p>TZP/R PLASTIC BASKET 18 1/2" x 12 1/2" x 10"</p>	RED	6	12
 <p>TZP/BL</p>	BLUE	6	12
 <p>TLB-5-R PLASTIC BASKET WITH HANDLE 4 WHEELS 22" x 16 1/2" x 17 1/2"</p>	RED	5	12
 <p>TMB METAL BASKET 16" x 12 1/4" x 7"</p>	BLACK	15	20
 <p>BS-7 WIRE BEVERAGE STAND 14" x 10" x 7 3/4"</p>	CHROME	10	25
 <p>BS-8 WIRE BEVERAGE STAND 28" x 14" x 8"</p>	CHROME	10	40

DUMP BINS

 <p>854C24 DUMP BIN- SQUARE 23"(L) x 23"(W) x 33"(H)</p>	CHROME	1	19
 <p>DT3636 DUMP BIN W/ CASTERS & ADJ. WOOD SHELF 36"(L) x 36"(W) x 30"(H) INCLUDES 2 LOCKING & 2 NON- LOCKING BRAKES</p>	CHROME	1	40
 <p>DT2436 FOLDING DUMP BIN WITH CASTERS 24"(L) x 36"(W) x 34"(H)</p>	CHROME	1	36

DUMP TABLES

Item & Description	Color	Pack	Wt
 <p>DT2840 FOLDING DUMP TABLE WITH CASTERS 28"(L) x 40"(W) x 30"(H) INCLUDES 2 LOCKING & 2 NON- LOCKING BRAKES BASKET MEASURES 4 5/8" DEEP</p>	CHROME	1	39
 <p>DT48-WTE FOLDING DUMP TABLE WITH CASTERS 48"(L) x 24"(W) x 32" (H) 4 5/8"(D) BASKET INCLUDES 2 LOCKING & 2 NON- LOCKING BRAKES</p>	WHITE	1	39
 <p>DBT/W FOLDING DUMP TABLE- WHITE 30"(L) x 60"(W) x 30"(H) 2" DEEP TABLETOP BIN</p>	WHITE	1	57







ECONOMY WIRE DISPLAYS

 <p>FCAP12 10"L x 15 1/2"W x 78"H 12 SHELVES HOLDS UP TO 72 CAPS See Countertop option on page 100</p>	BLACK	1	23
 <p>SPCAP4 SPINNING CAP FLOOR DISPLAY 64"(H) x 26" BASE INCLUDES SIGNHOLDER See Countertop option on page 100</p>	BLACK	1	10
 <p>SPR4 4 TIER SPINNER FLOOR DISPLAY W/ SIGNHOLDER 64"(H) x 24" BASE TIERS 12" APART, 6" PRONGS W/ 7 1/2" SPACE BETWEEN See Countertop option on page 100</p>	CHROME	1	4
 <p>WSR4 SHELF RACK 55"(H) x 22"(W) 4 SHELVES - 22"(W) x 13"(D)</p>	BLACK	1	27

GREETING CARD AND MAGAZINE DISPLAYS

Item	Description	Color	Pack	Wt
	SPLIT2 COUNTERTOP MAGAZINE SPINNER 28"(H) x 2"(D) POCKETS 12" BASE INCLUDES SIGNHOLDER	CHROME BLACK	1	7
	SPLIT4 LITERATURE SPACE SAVER SPINNER 40"(H) x 3/4"(D) POCKETS 24" BASE, INCLUDES SIGNHOLDER HOLDS 8 1/2" x 11" LITERATURE	CHROME	1	14
	CTSHF3 COUNTERTOP 3 TIER MULTI PURPOSE DISPLAY 24"(W) x 13"(H) x 15"(D)	BLACK	1	8
	CTSHF6 COUNTERTOP 6 TIER MULTI PURPOSE DISPLAY 30"(W) x 22"(H) x 19"(D) FOLDS FOR STORAGE	BLACK	1	8
	SPCARD12 12 POCKET CARD DISPLAY 30"(H) x 18" BASE 12 - 5 3/8" x 1 1/2"D POCKETS INCLUDES SIGNHOLDER	WHITE	1	8
	SPCARD24 24 POCKET CARD DISPLAY 64"(H) x 18" BASE 5 3/8"(W) x 8 3/4"(H) x 1 1/2"(D) POCKET SIZE ACCOMMODATES UP TO 5"(W) x 7 3/4" GREETING CARDS INCLUDES SIGNHOLDER	WHITE	1	17
	SPCARD48 48 POCKET CARD DISPLAY 64"(H) x 24" BASE 4 1/2"(W) x 8 3/4"(H) x 5 1/2"(D) POCKET SIZE ACCOMMODATES UP TO 5"(W) x 7 3/4" GREETING CARDS INCLUDES SIGNHOLDER	WHITE	1	19

ACRYLIC BOWL & BIN DISPLAYS

Item & Description	Color	Pack	Wt
 AFB-812 COUNTERTOP FOOD/CANDY BIN 8"L x 12 1/2"W x 8 1/2"H	CLEAR	4	9
 ACRF1 SHORT MULTI-PURPOSE ACRYLIC BOWL DISPLAY 20 1/3"L x 19 3/4"W x 30"H BOWL DIAMETER: 20 1/2" BLACK STEEL TUBING FRAME: 1 1/2"	CLEAR	1	20
 ACRF2 TALL MULTI-PURPOSE ACRYLIC BOWL DISPLAY 20 1/3"L x 19 3/4"W x 36"H BOWL DIAMETER: 20 1/2" BLACK STEEL TUBING FRAME: 1 1/2"	CLEAR	1	22
 ACRF3 COUNTERTOP MULTI-PURPOSE ACRYLIC BOWL DISPLAY 16"W x 24"H INCLUDES 3 BOWLS BOWL SIZE: 12 3/4"D SIGNHOLDER SLOT BLACK METAL FINISH BASE SIZE: 16"D	CLEAR	1	18
 ACRF12 4 TIER MULTI-PURPOSE ACRYLIC BOWL DISPLAY 18"W x 60"H SLOTTED UPRIGHT TUBING BOWLS CAN BE ADJUSTABLE ALONG THE UPRIGHT INCLUDES 16 BOWLS BOWL SIZE: 12 3/4"D INCLUDES SIGNHOLDER FRAME, FITS 8" x 11" SATIN NICKEL COAT FINISH BASE SIZE: 18"D x 1/4"	CLEAR	1	43
 R-1BT-4 4 TIER ACRYLIC BOWL DISPLAYS 65 1/2"(T) x 12"(BOWL SIZE) x 1/8 DIA x 6"H 16" BASE 7" x 5 1/2" SIGN HOLDER INCLUDED SILVER POLISHED METAL BASE	CLEAR	1	22

WOOD FLOOR DISPLAYS

Item & Description	Color	Pack	Wt
 <p>SC-S3T/M SC-S3T/B SQUARE 3-TIER TABLE 48"(L) x 42"(W) x 48"(H) 3/4" THICKNESS SHELVING TOP: 24" x 24" MIDDLE: 36" x 36" BOTTOM: 48" x 48" AND IS 10" FROM FLOOR</p>	MAPLE BLACK	1 1	135 135
 <p>L3T/M L3T/B OVAL 3 TIER TABLE 42"(L) x 42"(W) x 60"(H) 3/4" THICKNESS SHELVING TOP: 52" x 18" MIDDLE: 60" x 34" BOTTOM: 60" x 42" & IS 10" FROM FLOOR</p>	MAPLE BLACK	1 1	140 140
 <p>R3T/M RECTANGULAR 3 TIER TABLE WITH BLACK EDGE 66"(L) x 42"(W) x 42"(H) 1 1/2" THICKNESS SHELVING TOP: 52" x 18" MIDDLE: 60" x 34" BOTTOM: 60" x 42" AND IS 10" FROM FLOOR</p>	MAPLE	1	130
 <p>W3T/M RECTANGULAR 3 TIER TABLE 60"(L) x 42"(W) x 42"(H) 3/4" THICKNESS SHELVING TOP: 52" x 18" MIDDLE: 60" x 34" BOTTOM: 60" x 42" AND IS 10" FROM FLOOR</p>	MAPLE	1	130
 <p>TSHIRT T-SHIRT DISPLAYER - ROTATES CLEAR FRONT POCKETS 23 1/2"(L) x 23 1/2"(W) x 63"(H) INCLUDING CASTERS</p>	MAPLE	1	175

ISLAND DISPLAYS - CUBES

 <p>WIC9 12" CUBES (9 CUBES) - SINGLE SIDE 38"(W) x 18"(D) x 42"(H)</p>	MAPLE	1	59
<p>WIC18 12" CUBES (18 CUBES) - DOUBLE SIDE 38"(W) x 24"(D) x 42"(H)</p>	MAPLE	1	79
<p>WIC24 12" CUBES (24 CUBES) - DOUBLE SIDE 51 1/2"(W) x 24"(D) x 42"(H)</p>	MAPLE	1	86

SUNGLASS RACKS

Item & Description	Color	Pack	Wt
 <p>SU-32 MATERIAL: METAL WIRE HOLDS TOTAL 32 PAIRS INCLUDES SIGNHOLDER ROTATES FREELY 16"(L) x 24"(H) x 16"(W)</p>	SILVER	1	22
 <p>SU-72 MATERIAL: MDF/SILVER METAL WIRE/PVC/BEARING/MIRROR HOLDS TOTAL 72 PAIRS ROTATES FREELY 4 SIDED MIRRORS ALUMINIUM POLE 15"(L) x 64"(H) x 15"(W) BASE SIZE: 12 3/4"(L) x 10"(H)</p>	BLACK/SILVER	1	55
 <p>SU-120 MATERIAL: MDF/SILVER METAL WIRE/PVC/BEARING/MIRROR HOLDS 120 PAIRS ROTATES FREELY TOP SIGN HOLDER/ MDF SIDE FRAME 2 SIDE MIRROR 17"(L) x 69"(H) x 19"(W) SIGN HOLDER SIZE: 18 1/2"(L) x 7 1/2"(H) BASE SIZE: 12 3/4"(L) x 10"(H)</p>	BLACK/SILVER	1	48
 <p>SUNGLASS36 SUNGLASS RACK W/MIRROR HOLDS 36 PAIRS HEIGHT: 26" SILVER PACK : 1 WT : 8</p>	SILVER	1	8
 <p>SUNGLASS44 SUNGLASS RACK W/MIRROR HOLDS 44 PAIRS HEIGHT: 32" SILVER PACK : 1 WT : 9</p>	SILVER	1	9
 <p>CT-SUF6 ACRYLIC SUNGLASS RACK HOLDS 6 PAIRS CLEAR PACK : 10 WT : 2</p>	CLEAR	10	2

WOOD FLOOR DISPLAYS

Item & Description Color Pack Wt



IR5230
LARGE ANTIQUE WOOD TABLE
52"L x 30"W x 30"H
METAL FINISH LEGS
PACK: 1 WT: 62

IR54223
SMALL ANTIQUE WOOD TABLE
42"L x 23"W x 24"H
METAL FINISH LEGS
PACK: 1 WT: 44

CH-TABLE
CHAIN LEGGED WOOD TABLE
48"L x 30"W x 30"H
METAL FINISH LEGS
PACK: 1 WT: 103

ELD-4830
U-SHAPE WHITE NESTING TABLE
FRAME: 48 3/4"L x 36 1/4"W x 31"H
WOOD TOP: 46"L x 36"W
CHROME CORNER ACCENTS ON LEGS
PACK: 1 WT: 76

ELD-3TABLE
SMALL ANTIQUE WHITE WOOD TABLE
48"L x 30"W x 36"H
METAL FINISH LEGS
PACK: 1 WT: 132

PL-TLBL(MW)
LARGE NESTING TABLE
60"L x 32"W x 30"H
MATTE WHITE FINISH
PACK: 1 WT: 65

NEW PRODUCT



PL-TLBS(MW)
SMALL NESTING TABLE
47 5/8"L x 23 5/8"W x 24"H
MATTE WHITE FINISH
PACK: 1 WT: 45



PL-TLBS

DISPLAY TABLES- LAMINATED

Item & Description Color Pack Wt



TABLE/R
Wood Round Table Topper
36"D x 35"H x 2"T
Glossy White Lacquer Wood Finish
PACK: 1 WT: 44

AS SHOWN:
TABLE/O: 4 pc.
TABLE/R: 1 pc.PACK: 5 WT: 212

TABLE/Q
Wood Round Table Topper
44"L x 18"W x 21"H
Glossy White Lacquer Wood Finish
PACK: 1 WT: 42

AS SHOWN:
TABLE/O: 2 pc.
PACK: 2 WT: 84



CT6050-CM (SET)
REVERSIBLE WOOD TOP TABLE
60"(L) x 32"(W) x 30"(H)
50"(L) x 26"(W) x 24"(H)
1" x 2" TUBING CONSTRUCTION
GREY POWDER COAT FRAME
MAPLE/CHERRY
PACK: 1
WEIGHT: 150



CT6050-BW (SET)
REVERSIBLE WOOD TOP TABLE
60"(L) x 32"(W) x 30"(H)
50"(L) x 26"(W) x 24"(H)
1" x 2" TUBING CONSTRUCTION
GREY POWDER COAT FRAME
BLACK/WHITE
PACK: 1
WEIGHT: 150



LAMINATED MAPLE WOOD TOP TABLES

T6032 60"(L) x 32"(W) x 30"(H) 2" TUBING CONSTRUCTION	SATIN CHROME	1	94
T5026 50"(L) x 26"(W) x 24"(H) 2" TUBING CONSTRUCTION	SATIN CHROME	1	75

RISERS

Item Description Color Pack Wt

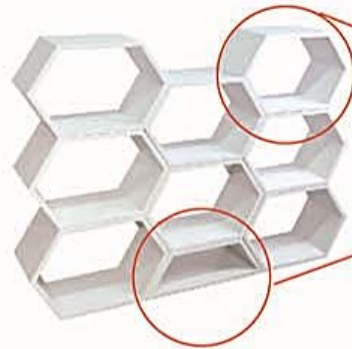

HEX-T
Wood Riser/Room Divider 20"L x 10"W x 13 3/4"H White Melamine Finish
PACK: 1 WT: 12 LBS.

HEX-B
Wood Riser/Room Divider 20"L x 10"W x 7"H White Melamine Finish
PACK: 1 WT: 10 LBS.

CAN BE BUILT LIKE BELOW:



REQ/BM
Wood Riser/Room Divider 22"L x 8 1/4"W x 7"H White Melamine Finish
PACK: 1 WT: 17 LBS.

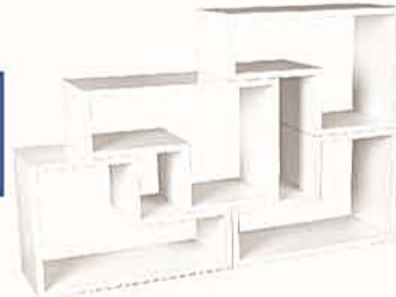

CUBE-1
Wood Cube- Small
12"L x 12"W x 15"H
Cinnamon Melamine Finish
PACK: 1 WT: 17



CUBE-2
Wood Cube- Large
15"L x 15"W x 18"H
Cinnamon Melamine Finish
PACK: 1 WT: 25

CUBE-L2
Linen Cube- Large
16"L x 16"W x 16"H
Linen with Aluminum Edges
PACK: 1 WT: 19



CUBE-L1
Linen Cube- Small
12"L x 12"W x 12"H
Linen with Aluminum Edges
PACK: 1 WT: 15

Item Description Color Pack Wt

COUNTERTOP- ACRYLIC DISPLAYS



FC4G-10

FC4W-10

FROSTED 4-SIDED CUBE 10"
FC4G-10 PACK: 1 WEIGHT: 15
FC4W-10 PACK: 1 WEIGHT: 15

FC4G-12

FC4W-12

FROSTED 4-SIDED CUBE 12"
FC4G-12 PACK: 1 WEIGHT: 16
FC4W-12 PACK: 1 WEIGHT: 16

COUNTERTOP- ACRYLIC DISPLAYS- 5 SIDED CUBES

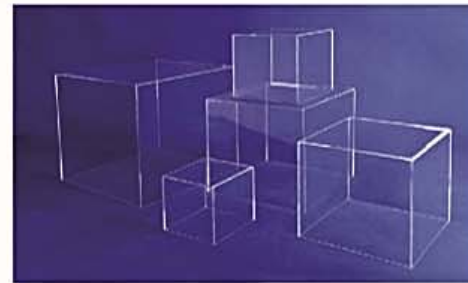

5 SIDED CUBES:
COLOR: CLEAR
FSC8
PACK: 1 WEIGHT: 2 LBS
8" X 8" X 8", 5/32" THICKNESS

FSC10
PACK: 1 WEIGHT: 3 LBS
10" X 10" X 10", 5/32" THICKNESS

FSC12
PACK: 1 WEIGHT: 5 LBS
12" X 12" X 12", 5/32" THICKNESS

FSC15
PACK: 1 WEIGHT: 7 LBS
15" X 15" X 15", 5/32" THICKNESS

COUNTERTOP- ACRYLIC DISPLAYS



1-SIDED OPEN ENDED ROUND
COLOR: CLEAR
CRS-IP-R
HEIGHT: 10"
BASE DIA: 10"
PACK: 1
WT: 3



1-SIDE OPEN ENDED SQUARE
COLOR: CLEAR
CRS-IP-S
HEIGHT: 10"
BASE DIA: 10"
PACK: 1
WT: 3



FRT8
PACK: 1 WEIGHT: 1 LBS
8" X 8", 5/32" THICKNESS

FRT10
PACK: 1 WEIGHT: 1 LBS
10" X 10", 5/32" THICKNESS





FRT12
PACK: 1 WEIGHT: 1 LBS
12" X 12", 5/32" THICKNESS

COUNTERTOP- ACRYLIC DISPLAYS- RISERS



U-SHAPED RISER- SET OF 5
CTP1104 PACK: 1 WT: 6
COLOR: BLACK
1: 13"L x 4 1/2"W x 6"H
2: 12"L x 4 1/2"W x 5"H
3: 11"L x 4 1/2"W x 4"H
4: 10"L x 4 1/2"W x 3"H
5: 9"L x 4 1/2"W x 2"H
THICKNESS: .18"

WOOD BASE & CONNECTOR FOR GLASS DISPLAYS

Item	Description	Color	Pack	Wt	
	RRB-B RRB-W	ROUND BASE - 30" DIAMETER BASE	BLACK	1	33
			WHITE	1	33
	OB-B OB-W	OVAL BASE - 54"(L) x 30"(W) x 6"(H) - W/ GROOVE	BLACK	1	46
			WHITE	1	46
	RB50-B RB50-W	RECTANGULAR BASE - 50"(L) x 12"(W) x 9"(H)	BLACK	1	40
			WHITE	1	40
	RB58-B RB58-W	RECTANGULAR BASE - 58"(L) x 14"(W) x 9"(H)	BLACK	1	49
			WHITE	1	49
	CON-2	2-WAY CONNECTOR	CHROME	100	20
	CON-3	3-WAY CONNECTOR	CHROME	100	23
	CON-4	4-WAY CONNECTOR	CHROME	100	29

TEMPERED GLASS SHELVES- 3/16" THICKNESS



GS1024	10" x 24" x 3/16"(T) TEMPERED GLASS	GLASS	10	45
GS1224	12" X 24" x 3/16"(T) TEMPERED GLASS	GLASS	10	53
GS1424	14" X 24" x 3/16"(T) TEMPERED GLASS	GLASS	5	33
GS1036	10" X 36" x 3/16"(T) TEMPERED GLASS	GLASS	5	31
GS1236	12" X 36" x 3/16"(T) TEMPERED GLASS	GLASS	5	37
GS1436	14" X 36" x 3/16"(T) TEMPERED GLASS	GLASS	5	42
GS1048	10" X 48" x 3/16"(T) TEMPERED GLASS	GLASS	5	45
GS1248	12" X 48" x 3/16"(T) TEMPERED GLASS	GLASS	5	53
GS1448	14" X 48" x 3/16"(T) TEMPERED GLASS	GLASS	5	73

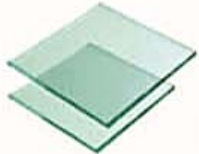

GS1212	12" x 12" x 3/16"(T) TEMPERED GLASS	GLASS	10	24
GS1414	14" x 14" x 3/16"(T) TEMPERED GLASS	GLASS	10	33



QRG12	12" QUARTER ROUND TEMPERED GLASS	GLASS	10	18
QRG14	14" QUARTER ROUND TEMPERED GLASS	GLASS	10	26

Item & Description

PLASTIC INJECTION MOLDED SHELVING



WHITE INJECTION MOLDED SHELF

IMS2413/W - 24"(W) x 13"(D)
IMS4813/W - 48"(W) x 13"(D)

WHITE
WHITE

4 10
4 19



BLACK INJECTION MOLDED SHELF

IMS2413/B - 24"(W) x 13"(D)
IMS4813/B - 48"(W) x 13"(D)

BLACK
BLACK

4 10
4 19



MAPLE INJECTION MOLDED SHELF

IMS2413/M - 24"(W) x 13"(D)
IMS4813/M - 48"(W) x 13"(D)

MAPLE
MAPLE

4 10
4 19



CHERRY INJECTION MOLDED SHELF

IMS2413/C - 24"(W) x 13"(D)
IMS4813/C - 48"(W) x 13"(D)

CHERRY
CHERRY

4 10
4 19

MELAMINE WOOD SHELVING- 3/4" THICKNESS



WS1224-W - 12" X 24"
WS1248-W - 12" X 48"
WS1448-W - 14" X 48"

WHITE
WHITE
WHITE

8 47
4 50
4 54



WS1224-B - 12" X 24"
WS1248-B - 12" X 48"
WS1448-B - 14" X 48"

BLACK
BLACK
BLACK

8 47
4 50
4 54



WS1224-M - 12" X 24"
WS1248-M - 12" X 48"
WS1448-M - 14" X 48"

MAPLE
MAPLE
MAPLE

8 47
4 50
4 54



WS1224-RW - 12" x 24"
WS1248-RW - 12" x 48"
WS1448-RW - 14" x 48"

HICKORY
HICKORY
HICKORY

8 47
4 50
4 54

GRID PANELS

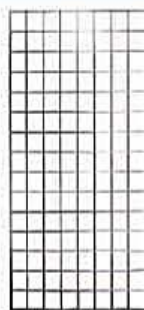

Item	Description	Color	Pack	Wt
GP15	1' X 5' GRIDWALL	CHROME	3	29
GPB15	(CONSTRUCTED WITH 1/4" WIRE)	BLACK	3	29
GPW15		WHITE	3	29
GP24	2' X 4' GRIDWALL	CHROME	3	36
GPB24	(CONSTRUCTED WITH 1/4" WIRE)	BLACK	3	36
GPW24		WHITE	3	36
GP25	2' X 5' GRIDWALL	CHROME	3	45
GPB25	(CONSTRUCTED WITH 1/4" WIRE)	BLACK	3	45
GPW25		WHITE	3	45
GP26	2' X 6' GRIDWALL	CHROME	3	53
GPB26	(CONSTRUCTED WITH 1/4" WIRE)	BLACK	3	53
GPW26		WHITE	3	53
GP27	2' X 7' GRIDWALL	CHROME	3	63
GPB27	(CONSTRUCTED WITH 1/4" WIRE)	BLACK	3	63
GPW27		WHITE	3	63
GP28	2' X 8' GRIDWALL	CHROME	3	73
GPB28	(CONSTRUCTED WITH 1/4" WIRE)	BLACK	3	73
GPW28		WHITE	3	73
GP44	4' X 4' GRIDWALL	CHROME	3	70
GPB44	(CONSTRUCTED WITH 1/4" WIRE)	BLACK	3	70
GPW44		WHITE	3	70

SLATGRID PANELS



Item	Description	Color	Pack	Wt
STG26/C	2'X6' SLATGRID PANEL	CHROME	3	64
STG26/B	2'X6' SLATGRID PANEL	BLACK	3	64
STG28/C	2'X8' SLATGRID PANEL	CHROME	3	89
STG28/B	2'X8' SLATGRID PANEL (CONSTRUCTED WITH 1/4" WIRE)	BLACK	3	89

GRID LEGS & BASES



GL24/CH	"T" LEG FOR GRIDWALL WITH LEVELERS THREAD 5/16"	CHROME	12	40
GL24/BLK		BLACK	12	40
GL24/WTE		WHITE	12	40



GPL12	12" LEG FOR GRIDWALL WITH LEVELERS THREAD 5/16"	CHROME	12	24
GPL12/B		BLACK	12	24
GPL12/W		WHITE	12	24



GP/3TB	TRIANGLE BASE FOR GRIDWALL WITH CASTERS THREAD 3/8"	CHROME	1	8
GPB/3TB		BLACK	1	8
GPW/3TB		WHITE	1	8



GP/4BA	4-WAY BASE FOR GRIDWALL WITH CASTERS THREAD 3/8"	CHROME	1	11
GPB/4BA		BLACK	1	11
GPW/4BA		WHITE	1	11



GP/G48	GONDOLA BASE FOR GRIDWALL WITH LEVELERS THREAD 3/8"	CHROME	1	13
GPB/G48		BLACK	1	13
GPW/G48		WHITE	1	13

GRID HOOKS



GP/NHK	NOTCH HOOK	CHROME	100	11
GPB/NHK		BLACK	100	11
GPW/NHK		WHITE	100	11
GP/H1		CHROME	100	15



GP/H1	1" HOOK	CHROME	100	15
GPB/H1		BLACK	100	15
GPW/H1		WHITE	100	15
GP/H2		CHROME	100	17



GP/H2	2" HOOK	CHROME	100	17
GPB/H2		BLACK	100	17
GPW/H2		WHITE	100	17
GP/H4		CHROME	100	17



GP/H4	4" HOOK	CHROME	100	17
GPB/H4		BLACK	100	17
GPW/H4		WHITE	100	17
GP/H6		CHROME	100	21



GP/H6	6" HOOK	CHROME	100	21
GPB/H6		BLACK	100	21
GPW/H6		WHITE	100	21
GP/H8		CHROME	100	24



GP/H8	8" HOOK	CHROME	100	24
GPB/H8		BLACK	100	24
GPW/H8		WHITE	100	24
GP/H10		CHROME	100	26



GP/H10	10" HOOK	CHROME	100	26
GPB/H10		BLACK	100	26
GPW/H10		WHITE	100	26
GP/H12		CHROME	100	28



GP/H12	12" HOOK	CHROME	100	28
GPB/H12		BLACK	100	28
GPW/H12		WHITE	100	28
WHK/R		RED	100	2

WHK/R ANIT-THEFT MAGNETIC SECURITY DISPLAY HOOK LOOK FITS 1/4" THICK HOOKS FOR PEGBOARD & SLATWALL HOOKS



WMD	MAGNETIC DETACHER KEY	SILVER	1	1
-----	-----------------------	--------	---	---

GRID BRACKETS



GP/8KB	8" KNIFE BRACKET	CHROME	50	25
GPB/8KB		BLACK	50	25
GPW/8KB		WHITE	50	25



GP/10KB	10" KNIFE BRACKET	CHROME	50	27
GPB/10KB		BLACK	50	27
GPW/10KB		WHITE	50	27



GP/12KB	12" KNIFE BRACKET	CHROME	50	29
GPB/12KB		BLACK	50	29
GPW/12KB		WHITE	50	29



GP/14KB	14" KNIFE BRACKET	CHROME	50	31
GPB/14KB		BLACK	50	31
GPW/14KB		WHITE	50	31

GRID FACEOUTS & WATERFALLS



GP/11	12" FACEOUT- SQUARE TUBING	CHROME	25	18
GPB/11		BLACK	25	18
GPW/11		WHITE	25	18



RG/12-CH	12" FACEOUT- RECT. TUBING	CHROME	25	26
----------	---------------------------	--------	----	----



GP/5H	5-HOOK WATERFALL- SQUARE TUBING	CHROME	25	33
GPB/5H		BLACK	25	33
GPW/5H		WHITE	25	33







GP/7B	7-BALL WATERFALL- SQUARE TUBING	CHROME	25	29
GPB/7B		BLACK	25	29
GPW/7B		WHITE	25	29



GRID FACEOUTS & WATERFALLS

Item	Description	Color	Pack	Wt
 GP/FRC	3" FACEOUT W/ DISC AT END	CHROME	50	21



GRID HANGRAILS & BRACKETS

	KHG680-CH KHG680-BLK KHG680-WTE	QUARTER CIRCLE 1-1/4" ROUND TUBE HANGRAIL	CHROME BLACK WHITE	10 10 10	28 30 30
	KHG681-CH KHG681-BLK KHG681-WTE	U-SHAPED 1-1/4" ROUND TUBE HANGRAIL	CHROME BLACK WHITE	10 10 10	29 31 31
	GP/RM GP/RT	12" HANGRAIL BKT FOR 1" & 1-1/16" ROUND HANGRAIL 12" HANGRAIL BKT FOR 1-1/4" ROUND HANGRAIL	CHROME CHROME	25 25	30 30
	GP/ML GPB/ML GPW/ML	MILLINERY DISPLAYER NO FOAM PAD 1 1/4"L x 5 1/8"H x 2 3/4"D	CHROME BLACK WHITE	25 25 25	15 15 15

GRID CONNECTOR & WALL MOUNT

	GP/JC GPB/JC GPW/JC	JOINING CLIP	CHROME BLACK WHITE	1000 1000 1000	36 36 36
	GP/WB GPB/WB GPW/WB	WALLMOUNT BRACKET FOR GRIDWALL	CHROME BLACK WHITE	100 100 100	33 33 33

GRID WIRE SHELF & CAP DISPLAYERS

	BSK2412/CH BSK2412/BLK BSK2412/WTE	24" X 12" WIRE SHELF	CHROME BLACK WHITE	6 6 6	27 27 27
	16-001CH 16-001BL 16-001WH	24" X 24" X 34-1/2" TRIANGULAR SHELF 24" X 24" X 34-1/2" TRIANGULAR SHELF 24" X 24" X 34-1/2" TRIANGULAR SHELF	CHROME BLACK WHITE	5 5 5	19 19 19
	GP/CAP-S GPB/CAP-S GPW/CAP-S	WIRE CAP DISPLAYER HOLDS 12 CAPS	CHROME BLACK WHITE	20 20 20	15 15 15

ACRYLIC DISPLAYS- GRIDWALL SIGN HOLDERS

	 ALHG/49	BROCHURE & PAMPHLET SIGN HOLDER 4 1/2"L x 1"W x 8 1/2"H	CLEAR	24	5
	 ALHG/811	MAGAZINE & CATALOG SIGN HOLDER 8 1/2"L x 2"W x 11"H	CLEAR	24	16
	GWP3031 GWP3033 GWP3035	5-1/2"(W) x 7"(H) - 3/32" THICKNESS 7"(W) x 11"(H) - 3/32" THICKNESS 8-1/2"(W) x 11"(H) - 3/32" THICKNESS	CLEAR CLEAR CLEAR	48 36 36	19 27 29
	GWP3032 GWP3034 GWP3036	7"(W) x 5-1/2"(H) - 3/32" THICKNESS 11"(W) x 7"(H) - 3/32" THICKNESS 11"(W) x 8-1/2"(H) - 3/32" THICKNESS	CLEAR CLEAR CLEAR	48 36 36	19 27 29



GRID DISPLAYERS- SHOE SHELF







	GP/SS	4" X 10" CLEAR SHOE SHELF	CLEAR	100	30
---	-------	---------------------------	-------	-----	----

GRID DISPLAYERS- BIN

	GWP3036	GRIDWALL - TRIPLE HOSEIERY BIN DISPLAY - 24"(L) X 7-1/2"(W) X 4-1/4"(H) - 1/8" THICK	CLEAR	6	22
---	---------	---	-------	---	----

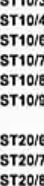
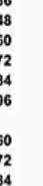
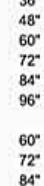







GRID DISPLAYERS- BOOK SHELF

	GWP3036F	J-RACK FLAT BOTTOM 1/8" T X 36"	CLEAR	12	16
	GWP3036F	J-RACK FLAT BOTTOM 1/8" T X 24"	CLEAR	12	11
	GWP3036F	J-RACK FLAT BOTTOM FOR BOOK 3/16" T X 24"	CLEAR	12	16

Item	Description	Color	Pack	Wt
MEDIUM DUTY STANDARDS				
	ST10/36 36" M.D SINGLE SLOT W/ 1/2" SLOTS ON 1" CENTERS	CHROME	10	11
	ST10/48 48" M.D SINGLE SLOT W/ 1/2" SLOTS ON 1" CENTERS	CHROME	10	13
	ST10/60 60" M.D SINGLE SLOT W/ 1/2" SLOTS ON 1" CENTERS	CHROME	10	15
	ST10/72 72" M.D SINGLE SLOT W/ 1/2" SLOTS ON 1" CENTERS	CHROME	10	18
	ST10/84 84" M.D SINGLE SLOT W/ 1/2" SLOTS ON 1" CENTERS	CHROME	10	22
	ST10/96 96" M.D SINGLE SLOT W/ 1/2" SLOTS ON 1" CENTERS	CHROME	10	23
	ST20/60 60" M.D DOUBLE SLOT W/ 1/2" SLOTS ON 1" CENTERS	CHROME	10	22
	ST20/72 72" M.D DOUBLE SLOT W/ 1/2" SLOTS ON 1" CENTERS	CHROME	10	26
	ST20/84 84" M.D DOUBLE SLOT W/ 1/2" SLOTS ON 1" CENTERS	CHROME	10	30
	ST20/96 96" M.D DOUBLE SLOT W/ 1/2" SLOTS ON 1" CENTERS	CHROME	10	33



MEDIUM DUTY STANDARD BRACKETS & ACCESSORIES

	GA6-CH 6" TAP-IN STYLE SHELF BRACKET	CHROME	50	12
	GA8-CH 8" TAP-IN STYLE SHELF BRACKET	CHROME	50	14
	GA10-CH 10" TAP-IN STYLE SHELF BRACKET	CHROME	50	16
	GA12-CH 12" TAP-IN STYLE SHELF BRACKET	CHROME	50	18
	GA14-CH 14" TAP-IN STYLE SHELF BRACKET	CHROME	50	20
	GA16-CH 16" TAP-IN STYLE SHELF BRACKET	CHROME	50	22
	A112-CH 1" & 1-1/16" ROUND TUBING HANGRAIL BRACKET	CHROME	25	22
	A212-CH 1 1/4" ROUND TUBING HANGRAIL BRACKET	CHROME	25	22
	WBL12-ZN WOOD SHELF BRACKET - 12" LEFT	SATIN ZINC	25	18
	WBL14-ZN WOOD SHELF BRACKET - 14" LEFT	SATIN ZINC	25	19
	WBL16-ZN WOOD SHELF BRACKET - 16" LEFT	SATIN ZINC	25	20
	WBR12-ZN WOOD SHELF BRACKET - 12" RIGHT	SATIN ZINC	25	19
	WBR14-ZN WOOD SHELF BRACKET - 14" RIGHT	SATIN ZINC	25	20
	WBR16-ZN WOOD SHELF BRACKET - 16" RIGHT	SATIN ZINC	25	21
	WBC12-ZN WOOD SHELF BRACKET - 12" CENTER	SATIN ZINC	25	19
	WBC14-ZN WOOD SHELF BRACKET - 14" CENTER	SATIN ZINC	25	20
	WBC16-ZN WOOD SHELF BRACKET - 16" CENTER	SATIN ZINC	25	21
	GC12-CH ADJUSTABLE SHELF BRACKET - 12"	CHROME	25	14
	GC14-CH ADJUSTABLE SHELF BRACKET - 14"	CHROME	25	15
	LKC-ZN DELUXE STYLE SNAP-IN CENTER SHELF REST RUBBER BUMPER SOLD SEPARATELY	SATIN ZINC	2500	30
	BU-CL RUBBER BUMPER	CLEAR	5000	1
	TCSS TOP CLIP TO HOLD STANDARD FOR SHOWCASE	CHROME	100	2
	BCSS BOTTOM CLIP TO HOLD STANDARD FOR SHOWCASE	CHROME	100	2

Item	Description	Color	Pack	Wt
MEDIUM DUTY STANDARD SADDLE BRACKETS				
	CR3-CH 3" RECT. HANGRAIL BRACKET	CHROME	25	12
	CR3-MAB FOR 1/2" SLOT ON 1" CENTERS	MATTE BLK	25	12
	CR3-SC	SATIN CHROME	25	12
	CR12-CH 12" RECT. HANGRAIL BRACKET	CHROME	25	27
	CR12-MAB FOR 1/2" SLOT ON 1" CENTERS	MATTE BLK	25	27
	CR12-SC	SATIN CHROME	25	27
	CR14-CH 14" RECT. HANGRAIL BRACKET	CHROME	25	28
	CR6-CH 6" RECT. HANGRAIL BRACKET	CHROME	25	23
	CR8-CH 8" RECT. HANGRAIL BRACKET	CHROME	25	25





MEDIUM DUTY STANDARD FACEOUTS & WATERFALLS

	TS/12-CH 12" STRAIGHT FACEOUT - SQUARE TUBING	CHROME	25	14
	TS/5H-CH 5-HOOK WATERFALL - SQUARE TUBING	CHROME	25	26
	TS/7B-CH 7-BALL WATERFALL - SQUARE TUBING	CHROME	25	26
	RDW12-CH 12" RECT TUBING STRAIGHT FACEOUT	CHROME	25	23
	RDW/5H-CH 5-HOOK WATERFALL - RECTANGULAR TUBING	CHROME	25	33
	RDW/7B-CH 7-CUBE WATERFALL - RECTANGULAR TUBING	CHROME	25	33





Item	Description	Color	Pack	Wt
HEAVY DUTY STANDARDS				
	ST30/48 48" H.D SINGLE SLOT W/ 1" SLOTS ON 2" CENTER	CHROME	10	40
	ST30/60 60" H.D SINGLE SLOT W/ 1" SLOTS ON 2" CENTER	CHROME	10	40
	ST30/72 72" H.D SINGLE SLOT W/ 1" SLOTS ON 2" CENTER	CHROME	10	46
	ST30/84 84" H.D SINGLE SLOT W/ 1" SLOTS ON 2" CENTER	CHROME	10	54
	ST30/96 96" H.D SINGLE SLOT W/ 1" SLOTS ON 2" CENTER	CHROME	10	62
	ST30/120 120" H.D SINGLE SLOT W/ 1" SLOTS ON 2" CENTER	CHROME	10	62
	ST30/144 144" H.D SINGLE SLOT W/ 1" SLOTS ON 2" CENTER	CHROME	10	62
	40-106ZC 6"(H) X 11/16"(D) RECESSED STANDARD	ZINC	8	42
	40-108ZC 8"(H) X 11/16"(D) RECESSED STANDARD	ZINC	4	27
	43-033CH BRACKET FOR SHELF 12" RECESSED STANDARD	CHROME	25	12
	43-034CH BRACKET FOR SHELF 14" RECESSED STANDARD	CHROME	25	14
	43-035CH BRACKET FOR SHELF 16" RECESSED STANDARD	CHROME	25	16

Item	Description	Color	Pack	Wt
HEAVY DUTY STANDARD BRACKETS & ACCESSORIES				
	G10-ZN 10" SHELF BRACKET FOR 1" ON 2" CENTER S.S	ZINC	25	21
	G12-ZN 10" SHELF BRACKET FOR 1" ON 2" CENTER S.S	ZINC	25	21
	G14-ZN 10" SHELF BRACKET FOR 1" ON 2" CENTER S.S	ZINC	25	25
	G16-CH 10" SHELF BRACKET FOR 1" ON 2" CENTER S.S	ZINC	25	28
	G18-CH 10" SHELF BRACKET FOR 1" ON 2" CENTER S.S	ZINC	25	33

Item	Description	Color	Pack	Wt
HEAVY DUTY STANDARD SADDLE BRACKETS				
	GR3-CH 3" RECT. HANGRAIL BRACKET 1" ON 2" CENTERS	CHROME	25	15
	GR3-MAB	MATTE BLK	25	15
	GR3-SC	SATIN CHROME	25	15
	G12-CH 12" RECT. HANGRAIL BRACKET 1" ON 2" CENTERS	CHROME	25	28
	GR12-MAB	MATTE BLK	25	28
	GR12-SC	SATIN CHROME	25	28
	G14-CH 14" RECT. HANGRAIL BRACKET 1" ON 2" CENTERS	CHROME	25	30

Item	Description	Color	Pack	Wt
HEAVY DUTY STANDARD FACEOUTS & WATERFALLS				
	RR3-CH 3" RECT. TUBE FACEOUT	CHROME	25	13
	RR12-CH 12" RECT. TUBE FACEOUT	CHROME	25	23
	RR12-SC 12" RECT. TUBE FACEOUT	SATIN CHROME	25	23
	RR14-CH 14" RECT. TUBE FACEOUT	CHROME	25	26
	RR5H-CH 5-HOOK WATERFALL - RECTANGULAR TUBING	CHROME	25	44
	RR7B-CH 7-CUBE WATERFALL - RECTANGULAR TUBING	CHROME	25	37
	RR5B STEP BRACKET FOR 1" ON 2" CENTERS 22"(L) x 8"(H) UPRIGHT	CHROME	25	55

Item	Description	Color	Pack	Wt
TUBING				
	RE2-CH 2"(L) X 1/2" X 1-1/2" RECTANGULAR TUBING	CHROME	10	15
	RE2-SC	SATIN CHROME	10	15
	RE3-CH 3"(L) X 1/2" X 1-1/2" RECTANGULAR TUBING	CHROME	10	28
	RE3-SC	SATIN CHROME	10	28
	RE4-CH 4"(L) X 1/2" X 1-1/2" RECTANGULAR TUBING	CHROME	10	28
	RE4-MAB	MATTE BLK	10	36
	RE4-SC	SATIN CHROME	10	36
	RE5-CH 5"(L) X 1/2" X 1-1/2" RECTANGULAR TUBING	CHROME	10	40
	RE6-CH 6"(L) X 1/2" X 1-1/2" RECTANGULAR TUBING	CHROME	10	45
	RE8-CH 8"(L) X 1/2" X 1-1/2" RECTANGULAR TUBING	CHROME	5	26
	RE10-CH 10"(L) X 1/2" X 1-1/2" RECTANGULAR TUBING	CHROME	5	36
	RE12-CH 12"(L) X 1/2" X 1-1/2" RECTANGULAR TUBING	CHROME	5	44
	RU4-CH 4"L ROUND TUBING - 1" DIA	CHROME	10	33
	RU6-CH 6"L ROUND TUBING - 1" DIA	CHROME	10	50
	RU8-CH 8"L ROUND TUBING - 1" DIA	CHROME	10	68
	RU10-CH 10"L ROUND TUBING - 1" DIA	CHROME	5	43
	RU12-CH 12"L ROUND TUBING - 1" DIA	CHROME	5	53
	RX4-CH 4"L ROUND TUBING - 1-1/8" DIA	CHROME	10	37
	RX6-CH 6"L ROUND TUBING - 1-1/8" DIA	CHROME	10	55
	RX8-CH 8"L ROUND TUBING - 1-1/8" DIA	CHROME	10	71
	RY4-CH 4"L ROUND TUBING - 1-1/4" DIA	CHROME	10	40
	RY6-CH 6"L ROUND TUBING - 1-1/4" DIA	CHROME	10	60
	RY8-CH 8"L ROUND TUBING - 1-1/4" DIA	CHROME	10	75
	RY10-CH 10"L ROUND TUBING - 1-1/4" DIA	CHROME	5	51
	RY12-CH 12"L ROUND TUBING - 1-1/4" DIA	CHROME	5	58

Item	Description	Color	Pack	Wt
TUBING ACCESSORIES				
	EC4-CH END CAPS FOR 1/2" X 1-1/2" RECTANGULAR TUBING	CHROME	100	10
	EC4-MAB	MATTE BLK	100	10
	EC4-SC	SATIN CHROME	100	10
	EC5-CH EXTENDED END CAP FOR 1/2" X 1-1/2" RECTANGULAR TUBING	CHROME	100	14
	EC1-CH END CAP FOR 1" & 1-1/16" ROUND TUBING	CHROME	100	10
	EC2-CH END CAP FOR 1-1/4" ROUND TUBING	CHROME	100	10
	RE/SP-ZN SPLICER FOR 1/2" X 1-1/2" RECTANGULAR TUBING	ZINC	100	10
	RU/SP-ZN SPLICER FOR 1" ROUND TUBING	ZINC	100	11
	RY/SP-ZN SPLICER FOR 1 1/4" ROUND TUBING	ZINC	100	13

Item	Description	Color	Pack	Wt
------	-------------	-------	------	----

SADDLE MOUNT HARDWARE

	RH/12-CH	12" RECTANGULAR FACE-OUT - RECT. HANGRAIL	CHROME	25	24
	RH/12-SC		SATIN CHROME	25	24
	RH/12-MAB		MATTE BLK	25	24
	RH/5H-CH	5-HOOK WATERFALL- RECTANGULAR TUBING	CHROME	25	29
	RH/7B-CH	7-BALL WATERFALL- RECTANGULAR TUBING	CHROME	25	36
	RH/5B	STEP BRACKET WITH STOPPER 22"(L) x 8"(H) UPRIGHT	CHROME	25	55
	H4-CH	4" HOOK FOR RECTANGULAR HANGRAIL	CHROME	100	15
	H6-CH	6" HOOK FOR RECTANGULAR HANGRAIL	CHROME	100	18
	H9-CH	9" HOOK FOR RECTANGULAR HANGRAIL	CHROME	100	26
	H12-CH	12" HOOK FOR RECTANGULAR HANGRAIL	CHROME	100	28
	H4-SC	4" HOOK FOR RECTANGULAR HANGRAIL	SATIN CHROME	100	15
	H6-SC	6" HOOK FOR RECTANGULAR HANGRAIL	SATIN CHROME	100	18
	H9-SC	9" HOOK FOR RECTANGULAR HANGRAIL	SATIN CHROME	100	26
	H12-SC	12" HOOK FOR RECTANGULAR HANGRAIL	SATIN CHROME	100	28

WALL MOUNT HARDWARE

	TB/12-CH	12" FACEOUT FOR WALL MOUNT	CHROME	25	10
	TB/7B-CH	7-BALL WATERFALL FOR WALL MOUNT	CHROME	25	28
	TB/5H-CH	5-HOOK WATERFALL FOR WALL MOUNT	CHROME	25	25

Item	Description	Price	Pack	Wt
------	-------------	-------	------	----

BULLETIN SIGN HOLDERS

	NEW SHF/1	BEIGE DECORATIVE FLOOR SIGNHOLDER		
		1 SIGN HOLDER FRAME- 23"L x 23 1/4"D x 60" SIGN HOLDER: 22"W x 28"H DECORATIVE CURL BASE	BEIGE	1 26
	NEW SHF/2	SATIN CHROME SINGLE SIGN HOLDER		
		1 SIGN HOLDER FRAME- 23"L x 23 1/4"D x 60" SIGN HOLDER: 22"W x 28"H FOLDABLE BASE- 18"L EACH SIDE	SATIN CHROME	1 18
	BH26-CH BH26-MAB	SINGLE SIGN HOLDER		
		1 SIGN HOLDER FRAME- 22"(W) x 28" (H) TOP LOAD METAL TWIN STEM W/ FLAT BASE	CHROME MATTE BK.	1 15 1 15
	BH30-CH BH30-MAB	SINGLE SIGN HOLDER		
		1 SIGN HOLDER FRAME- 22"(W) x 28" (H) TOP LOAD W/ TUBULAR BASE	CHROME MATTE BK.	1 19 1 19
	BH55-CH BH55-MAB	TWO TIER SIGN HOLDER		
		2 SIGN HOLDER FRAMES - 22"(W) x 28"(H) TOP LOAD W/ TUBULAR BASE	CHROME MATTE BK.	1 23 1 23
	BH77-CH BH77-MAB	THREE TIER SIGN HOLDER		
		3 SIGN HOLDER FRAMES: 22"(W) x 28"(H) TOP LOAD W/ TUBULAR BASE	CHROME MATTE BK.	1 45 1 45

CLIP SIGN HOLDERS



Item & Description	Color	Pack	Wt
ALISIGN/6 HEIGHT: 6" BASE DIAMETER: 3"	CHROME	50	6
ALISIGN/9 HEIGHT: 9" BASE DIAMETER: 3"	CHROME	50	7
ALISIGN/12 HEIGHT: 12" BASE DIAMETER: 3"	CHROME	50	8



POP-1 DOUBLE CLIP SIGN HOLDER 3 1/2" LONG CLIP SIZE - 3/4"(W) x 1 1/2"(H)	CLEAR	20	1
---	-------	----	---



POP-2 CLIP-ON SIGN HOLDER WITH SPRING LOADED GRAPHIC HOLDER 4" LONG CLIP SIZE - 3"(W) x 1"(H)	CLEAR	20	1
---	-------	----	---



POP-3 CLIP-ON SIGN HOLDER WITH SPRING LOADED GRAPHIC HOLDER 6 1/4" LONG CLIP SIZE - 3"(W) x 1"(H)	CLEAR	20	1
---	-------	----	---



POP-4 CLIP-ON SIGN HOLDER WITH FIXED GRAPHIC HOLDER 3 5/8" LONG CLIP SIZE - 2 1/4"(W) x 3/4"(H)	CLEAR	20	1
---	-------	----	---



POP-5 SMALL CLIP WITH 2" POST & MAGNET CLIP SIZE - 0.75"(W) x 1.5"(H)	CLEAR & MAGNET	20	1
--	----------------	----	---



POP-6 BIG CARD HOLDER WITH 2" POST & MAGNET CLIP SIZE - 2"(W) x 1.4"(H)	CLEAR & MAGNET	20	1
--	----------------	----	---

STEM MOUNT SIGN HOLDERS



Item & Description	Color	Pack	Wt
HORIZONTAL METAL SIGN HOLDER			
MC57-CH 7"W x 5 1/2"H SIGN HOLDER W/ 1/4" x 3/8" FITTING	CHROME	25	9
MC711-CH 11"W x 7 1/2"H SIGN HOLDER W/ 1/4" x 3/8" FITTING	CHROME	25	14
MC811-CH 11"W x 8"H SIGN HOLDER W/ 1/4" x 3/8" FITTING	CHROME	25	15



Item & Description	Color	Pack	Wt
HORIZONTAL ACRYLIC SIGN HOLDER			
PJ57-CL 7"W x 5 1/2"H CLEAR SIGN HOLDER W/ 3/8" FITTING	CHROME	25	10
PJ711-CL 11"W x 7 1/2"H CLEAR SIGN HOLDER W/ 3/8" FITTING	CHROME	25	19
PJ811-CL 11"W x 8 1/2"H CLEAR SIGN HOLDER W/ 3/8" FITTING	CHROME	25	21



SC22-CH ALL PURPOSE CLAMPS	CHROME	100	13
--------------------------------------	--------	-----	----



Item & Description	Color	Pack	Wt
THREADED STEM			
M3-CH 3"(L) x 3/8" THREADED STEM	CHROME	100	10
M6-CH 6"(L) x 3/8" THREADED STEM	CHROME	100	20



Item & Description	Color	Pack	Wt
SWEDGED STEM			
NS3-CH 3"(L) x 3/8" SWEDGED STEM	CHROME	100	10
NS6-CH 6"(L) x 3/8" SWEDGED STEM	CHROME	100	20



Item & Description	Color	Pack	Wt
MAGNETIC CLAMP			
MAG/S 90 DEGREE MAGNETIC CLAMP SWEDGED STEM	CHROME	100	22
MAG/T 90 DEGREE MAGNETIC CLAMP THREADED STEM FITS 3/8" THREAD	CHROME	100	22



Item & Description	Color	Pack	Wt
MAGNETIC BASE			
MAG/LS 4" WIDE MAGNETIC BASE FITS 3/8" SWEDGED STEM	CHROME	100	29
MAG/LT 4" WIDE MAGNETIC BASE FITS 3/8" THREADED STEM	CHROME	100	29

RETRACTABLE BELT STANCHIONS & ACCESSORIES



STA-BOWL
BOWL SIZE: 12 3/4"
STANCHION SOLD SEPARATELY SEE BELOW- JCB-G02/G03

Color: CLEAR Pack: 1 Wt: 3



STA-811
SIGN HOLDER- 8" x 11"
STANCHION SOLD SEPARATELY SEE BELOW- JCB-G02/G03

Color: BLACK Pack: 2 Wt: 3



JCB-G02
6' -6" BELT

Color: BLACK Pack: 1 Wt: 19



JCB-G03
6' -6" BELT

Color: STAINLESS Pack: 1 Wt: 17

TURN TABLES



TT13
ELECTRONIC TURNTABLE 13 1/2" DISC

Color: BLACK Pack: 1 Wt: 10



TT17
ELECTRONIC TURNTABLE 17" DISC

Color: BLACK Pack: 1 Wt: 12



2112A
ELECTRIC TURNTABLE
1 ROTATION/24" 2 1/2 RPM
SIZE: 4 1/8"(D) x 1 3/4"(H)
SPEED NOT ADJUSTABLE

Color: WHITE Pack: 1 Wt: 2



2112D
ELECTRIC TURNTABLE
1 ROTATION/24" 2 1/2 RPM
SIZE: 6"(D) x 1 3/4"(H)
SPEED NOT ADJUSTABLE

Color: WHITE Pack: 1 Wt: 6

SECURITY MIRRORS



CONVEX CIRCULAR MIRROR
SMR18
18" DIAMETER
SMR24
24" DIAMETER
SMR32
32" DIAMETER
MOUNTING CLIPS INCLUDED

MIRROR Pack: 1 Wt: 4
MIRROR Pack: 1 Wt: 6
MIRROR Pack: 1 Wt: 12



180 HALF DOME MIRROR
SMH20
1/2 of 20" DIAMETER
SMH24
1/2 of 24" DIAMETER
MOUNTING CLIPS INCLUDED

MIRROR Pack: 1 Wt: 1
MIRROR Pack: 1 Wt: 1







90 QUARTER DOME MIRROR
SMQ20
1/4 of 20" DIAMETER
SMQ24
1/4 of 24" DIAMETER
MOUNTING CLIPS INCLUDED

MIRROR Pack: 1 Wt: 1
MIRROR Pack: 1 Wt: 1

POLY DISPENSING RACKS

Item	Description	Color	Pack	Wt
 R30	3-ROLL POLY DISPENSING RACK	CHROME	1	34
 R31	ONE ROLL POLY DISPENSING RACK	CHROME	1	14
 R32	BAGGING JACK W/ROUND BASE	CHROME	1	14



FULL LENGTH MIRRORS

Item	Description	Color	Pack	Wt
 PL-MR	FRAME : 23"(W) x 69"(H) MIRROR : 20"(W) x 60"(H) INCLUDES 3" CASTERS 2 NON LOCKING & 2 LOCKING	MIRROR	1	70
 R40 MIRROR	MIRROR FOR R40 & R41 MIRROR SIZE : 19"W x 58H	MIRROR	1	40
 TSM	SINGLE TILTED MIRROR IN CHROME MIRROR SIZE : 20" x 60" 67 1/4" HEIGHT	MIRROR	1	48
 3WM	3 WAY - MIRROR CENTER MIRROR SIZE : 20" x 60" SIDE MIRROR SIZE : 18" x 60" 67 1/4" HEIGHT	MIRROR	1	120



MOBILE HANGER STORAGE RACKS

	<p>NEW PRODUCT</p> <p>HSR7 HANGER SORTER RACK- LARGE 27"L x 18"W x 55" H INCLUDES 6 BARS 2 BRAKE & 2 NON BRAKE CASTERS GREY FINISH PK: 1 WT: 28</p>		<p>NEW PRODUCT</p> <p>HSR3 HANGER SORTER RACK- SMALL 30"L x 22"W x 31"H INCLUDES 3 BARS 2 BRAKE & 2 NON BRAKE CASTERS GREY FINISH PK: 1 WT: 20</p>
---	--	---	---

HANGERS & ACCESSORIES

14" BOTTOM HANGER		14" TOP HANGER		
	SH14C		SH14C	<p>SH14C SH14B SH17C SH17B PACK 100 WT: 19 LBS.</p>





WOOD HANGERS

	WH17C	17" WOOD DREE & SHIRT HANGER METAL CLIPS SWIVEL HOOK (HEAVY WEIGHT)	WOOD	100	23
	WH14C	14" WOOD SKIRT & PANTS HANGER METAL CLIPS SWIVEL HOOK (HEAVY WEIGHT)	WOOD	100	28

HANGER STACKER & RETRIEVER

	HS4-CH	HANGER STACKER	CHROME	10	9
	P48-CH	54" HANGER RETRIEVER	CHROME	10	12

HANGER CLIPS

	S-HOOK	S-HOOK 1/8"(T) CHROME PK: 500 WT: 21		289-12CW	12 CLIP WAND RETAILERS IVORY PK: 50 WT: 20
	BSC/B BSC/W	3" S HOOK WITH 2" CLAMP BLACK WHITE PK: 50 WT: 3		SC/B SC/W	SWIVEL CLIP BLACK WHITE PK: 100 WT: 1

Item & Description

Color

Pack Wt

TAGGING GUNS & ACCESSORIES



JB100
STANDARD TAGGING GUN

BLACK

1 2



JBF100
FINE TAGGING GUN

SKY BLUE

1 2

STANDARD FASTENER

FASTENER 1"
FASTENER 2"
FASTENER 3"

CLEAR
CLEAR
CLEAR

5,000 1
5,000 1
5,000 1

FINE FASTENER

FINE FASTENER 1"
FINE FASTENER 2"
FINE FASTENER 3"

CLEAR
CLEAR
CLEAR

5,000 1
5,000 1
5,000 1



PAPER PRICE TAGS

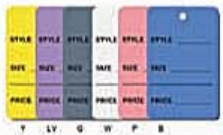

PT1
PRICE TAG- SMALL
SIZE : 1.25" X 1.875"
CHOOSE FROM 6 COLORS: YELLOW, LAVENDAR, GREY,
WHITE, PINK, BLUE

Y, LV,G,W,P,B

1,000 5

** NOT SOLD IN MULTI COLORS **



PT3
PRICE TAG- LARGE
SIZE : 1.75" X 2.75"
CHOOSE FROM 6 COLORS: YELLOW, LAVENDAR, GREY,
WHITE, PINK, BLUE

Y, LV,G,W,P,B

1,000 5

** NOT SOLD IN MULTI COLORS **



PT2
PERFORATED PRICE TAG- SMALL
SIZE : 1.25" X 1.875"
CHOOSE FROM 6 COLORS: YELLOW, LAVENDAR, GREY,
WHITE, PINK, BLUE

Y, LV,G,W,P,B

1,000 5

** NOT SOLD IN MULTI COLORS **



PT4
PERFORATED PRICE TAG- LARGE
SIZE : 1.75" X 2.75"
CHOOSE FROM 6 COLORS: YELLOW, LAVENDAR, GREY,
WHITE, PINK, BLUE

Y, LV,G,W,P,B

1,000 5

** NOT SOLD IN MULTI COLORS **

Item & Description

Color

Pack Wt

MESSAGE CARDS- SALE, SPECIAL, BLANK



SC-15 11" x 7" 50PCS
SC-14 7" x 5" 50PCS
SC-13 5" x 3" 50PCS
SC-12 3" x 2" 50PCS
SC-11 2" x 1" 50PCS

N/A
N/A
N/A
N/A
N/A

50 2
50 2
50 2
50 2
50 2



SC-35 11" x 7" 50PCS
SC-34 7" x 5" 50PCS
SC-33 5" x 3" 50PCS
SC-32 3" x 2" 50PCS
SC-31 2" x 1" 50PCS

N/A
N/A
N/A
N/A
N/A

50 2
50 2
50 2
50 2
50 2

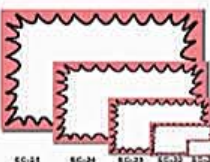

SC-25 11" x 7" 50PCS
SC-24 7" x 5" 50PCS
SC-23 5" x 3" 50PCS
SC-22 3" x 2" 50PCS
SC-21 2" x 1" 50PCS

N/A
N/A
N/A
N/A
N/A

50 2
50 2
50 2
50 2
50 2

ZIPPER BAGS



(2ML, CLEAR)

ZIPPERBAGS 2" X 2"
ZIPPERBAGS 2" X 3"
ZIPPERBAGS 2" X 8"
ZIPPERBAGS 3" X 3"
ZIPPERBAGS 3" X 4"
ZIPPERBAGS 3" X 5"
ZIPPERBAGS 4" X 4"
ZIPPERBAGS 4" X 6"
ZIPPERBAGS 5" X 7"
ZIPPERBAGS 6" X 9"
ZIPPERBAGS 8" X 10"

CLEAR
CLEAR
CLEAR
CLEAR
CLEAR
CLEAR
CLEAR
CLEAR
CLEAR
CLEAR
CLEAR

1,000 1
1,000 1
1,000 1
1,000 1
1,000 1
1,000 1
1,000 1
1,000 1
1,000 1
1,000 1
1,000 1

OPP BAGS



(2ML, CLEAR)

OPPBAGS 2" X 2"
OPPBAGS 2" X 3"
OPPBAGS 3" X 3"
OPPBAGS 3" X 4"
OPPBAGS 3" X 5"
OPPBAGS 4" X 6"
OPPBAGS 6" X 9"
OPPBAGS 8" X 10"

CLEAR
CLEAR
CLEAR
CLEAR
CLEAR
CLEAR
CLEAR
CLEAR

1,000 1
1,000 1
1,000 1
1,000 1
1,000 1
1,000 1
1,000 1
1,000 1